

# F6 MultiTrack Field Recorder

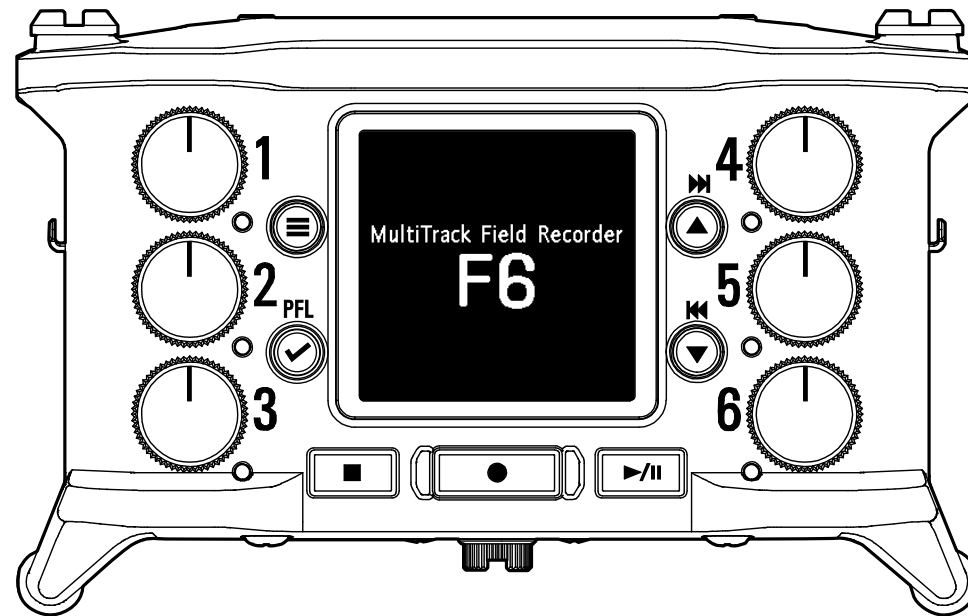

## Operation Manual

You must read the Usage and Safety Precautions before use.

© 2019 ZOOM CORPORATION

Copying or reprinting this manual in part or in whole without permission is prohibited.

Product names, registered trademarks and company names in this document are the property of their respective companies. All trademarks and registered trademarks in this document are for identification purposes only and are not intended to infringe on the copyrights of their respective owners.

Proper display is not possible on grayscale devices.

# Notes about this Operation Manual

---

You might need this manual in the future. Always keep it in a place where you can access it easily. The contents of this document and the specifications of the product could be changed without notice.

- © Windows® is a trademark or registered trademark of Microsoft® Corporation.
- © Mac, macOS, iPad, iPhone and iPod touch are trademarks or registered trademarks of Apple Inc.
- © The SD, SDHC and SDXC logos are trademarks.
- © The Bluetooth® word mark and logo are registered trademarks of Bluetooth® SIG, Inc. and these marks are used under license by Zoom Corporation.
- © Other product names, registered trademarks and company names in this document are the property of their respective companies.

Note: All trademarks and registered trademarks in this document are for identification purposes only and are not intended to infringe on the copyrights of their respective owners.

Recording from copyrighted sources, including CDs, records, tapes, live performances, video works and broadcasts, without permission of the copyright holder for any purpose other than personal use is prohibited by law. Zoom Corporation will not assume any responsibility related to infringements of copyrights.

# Introduction

---

Thank you very much for purchasing a ZOOM **F6** multitrack field recorder. The **F6** provides the following features in a compact form.

## ● Record the quietest and loudest sounds at high quality with 32-bit float WAV format

The high-quality analog input circuits can handle signals ranging from the most delicate to a professional maximum level of +24 dBu.

In addition to 16/24-bit WAV recording, 32-bit float WAV recording, which does not require input level adjustment, is also supported.

With 32-bit float WAV format, the recording resolution can be retained even when changing levels greatly after recording.

## ● Simultaneously record 6 channels and 14 tracks

Up to 14 tracks can be recorded simultaneously, including 16/24-bit WAV and 32-bit float WAV for Inputs 1–6 along with left and right tracks of a stereo mix.

## ● Support for three types of batteries

A USB mobile battery, L battery or AA batteries can be used for power.

## ● Two remote control options

Wireless control is possible by installing a ZOOM wireless adapter (e.g. BTA-1) and using the F6 Control iOS app.

Moreover by connecting an F6 Control, which is a mixer-style controller designed especially for F Series recorders, with a USB cable, 60mm track faders, LED level meters and various transport buttons can be used for intuitive sound control. Combined with the F6 Control iOS app, iPhones and iPads can also be used as large meters with excellent visibility.

## ● Support for SMPTE timecode input and output along with wireless timecode input

The **F6** uses a high-precision oscillator that enables it to independently generate accurate timecode with a discrepancy of less than 0.5 frames

per 24 hours.

If a BTA-1 dedicated wireless adapter is installed, wireless timecode can be received from a Timecode Systems UltraSync BLUE and written to recorded files.

## ● Headphone jack with 100mW+100mW maximum output

Clear headphone monitoring is possible using the digital boost function while sending audio signals to a video camera or other device from the LINE OUT jack.

## ● Flexible signal routing also makes mixer use possible

Pre-fader and post-fader signals from inputs 1–6 can be routed to outputs freely.

## ● Phantom power supply (+24 V or +48 V)

This can be set for each input separately.

## ● USB audio interface use with up to 6 ins and 4 outs possible

Use as a 2-in/2-out or 6-in/4-out audio interface (driver required for Windows).

## ● Output multitrack audio by USB while recording

While recording to the installed SD card, multitrack audio can be sent to and from a computer by USB with up to 8 inputs (6 inputs + L/R stereo mix) and 4 outputs.

This enables simultaneous backup recording and Internet live streaming.

## ● 360° audio

Ambisonic mode enables 360° spatial audio recording using VR mics. Decoding from Ambisonic format A to format B is supported along with gain and setting link functions.

# Contents

---

<b>Notes about this Operation Manual</b> .....	02
<b>Introduction</b> .....	03
<b>Contents</b> .....	04
<b>Names of parts</b> .....	06
<b>Connecting mics/other devices to Inputs 1–6</b> .....	08
Equipment connection examples.....	09
<b>Display overview</b> .....	10
<b>Preparations</b> .....	13
Supplying power.....	13
Loading SD cards.....	15
Turning the power on and off.....	16
Setting the language.....	17
Setting the date and time.....	18
Setting the power supply used.....	20
<b>Recording</b> .....	22
Recording process.....	22
Setting the recording file format.....	23
Selecting inputs and adjusting levels.....	24
Recording.....	26
Setting the sampling rate.....	27
Setting the recording mode (bit depth).....	29
Setting MP3 file bit rate (MP3).....	31
Setting the LR Track.....	33
Capturing audio before recording starts.....	35
Setting the recording time display.....	36
Setting the playback time display.....	38
Folder and file structure.....	40
Move the previously recorded take to the FALSE TAKE folder.....	42
<b>Recorded take settings</b> .....	43
Changing the note for the next take recorded.....	43
Setting and managing recorded scene names.....	45
Changing the track name of the next take recorded (Track Name).....	48
Changing the number of the next take recorded.....	50
<b>Playback</b> .....	51
Playing recordings.....	51
Mixing takes.....	52
Monitoring the playback signals of specific tracks during playback.....	54
Changing the repeat playback setting.....	56
<b>Take and folder operations</b> .....	57
Working with takes and folders.....	57
Overview of metadata (take information) stored in files.....	63
Checking and editing take metadata.....	64
Writing a sound report.....	73
<b>Input settings</b> .....	76
Adjusting the input signal monitoring balance.....	76
Monitoring the input signals of specified tracks.....	77
Setting the input source.....	78
Setting the monitoring volume on the PFL screen.....	80
Cutting low-frequency noise.....	82
Input limiter.....	84
Inverting the input phase.....	90
Changing the phantom power settings.....	92
Applying delay to input signals.....	94
Linking inputs as a stereo pair.....	96
Adjusting multiple track input levels together.....	98
Changing the automatic mixing setting.....	99
Setting the Ambisonic format.....	101
Setting the mic position used for Ambisonic recording.....	104
<b>Output settings</b> .....	106
Setting signals sent to the headphone output.....	106
Outputting alerts through headphones.....	109
Setting the headphone output volume curve.....	110
Boosting headphone output to alleviate interference from recorded sound.....	111
Setting the output level.....	113
Applying delay to the output.....	115
Output Limiter.....	116
Selecting signals sent to the line outputs.....	120

<b>Timecode</b> .....	122
Timecode overview.....	122
Setting timecode.....	124
Setting the automatic timecode recording delay.....	133
Setting timecode initialization used at startup.....	134
<b>Using USB functions</b> .....	136
Exchanging data with a computer.....	136
Using as an audio interface.....	138
Using SD card recording and audio interface functions at the same time.....	140
Audio interface settings.....	142
Using an FRC-8 as a controller.....	143
Setting the type of keyboard connected to the FRC-8.....	145
Setting user keys for the FRC-8.....	147
Setting the FRC-8 LED brightness.....	149
Updating the FRC-8 firmware.....	151
Operating with an iOS device.....	154
<b>Other settings</b> .....	161
Setting the level meter peak hold time.....	161
Setting the LED brightness.....	162
Making display settings.....	164
Setting how marks are added manually.....	167
Setting the buttons held.....	169
<b>Other functions</b> .....	171
Checking SD card information.....	171
Testing SD card performance.....	172
Formatting SD cards.....	175
Checking the <b>F6</b> Shortcut List.....	176
Backing up and loading <b>F6</b> settings.....	177
Restoring default setting values.....	180
Checking the firmware version.....	181
Updating the firmware.....	182

<b>Appendix</b> .....	183
Troubleshooting.....	183
Metadata list.....	185
List of shortcuts.....	189
Block diagrams.....	190
Specifications.....	197

# Names of parts

## Front

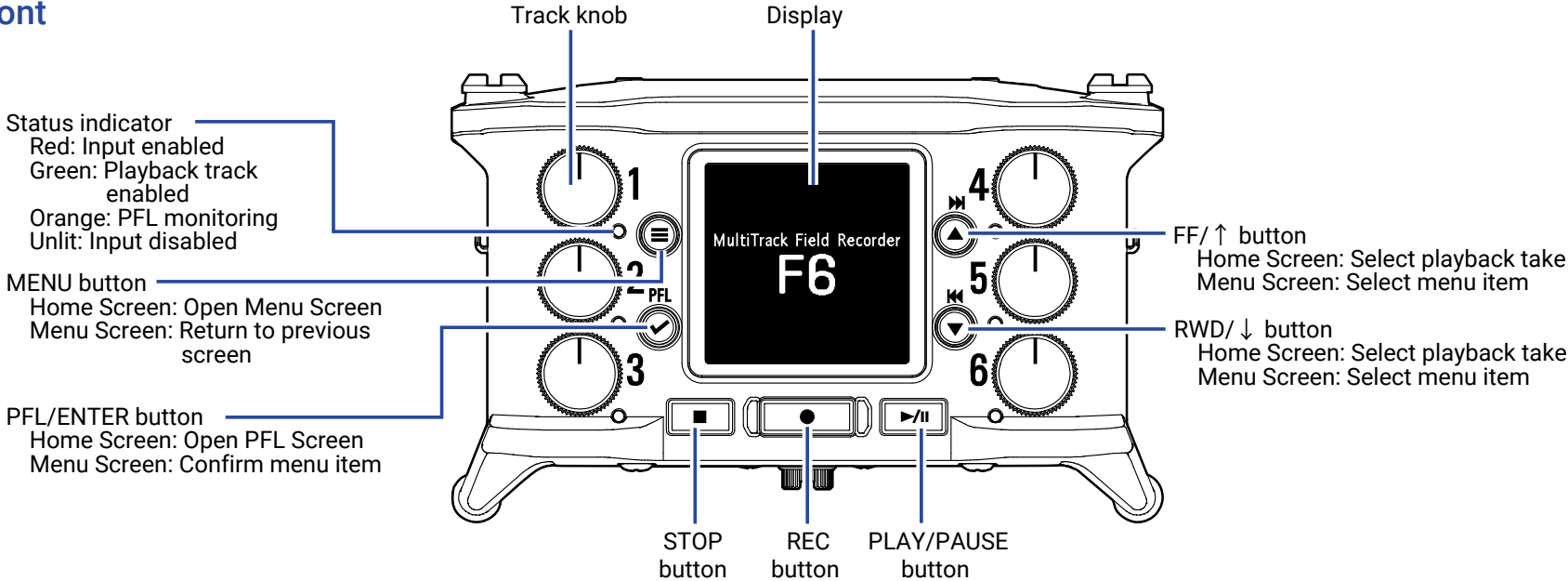

## Back

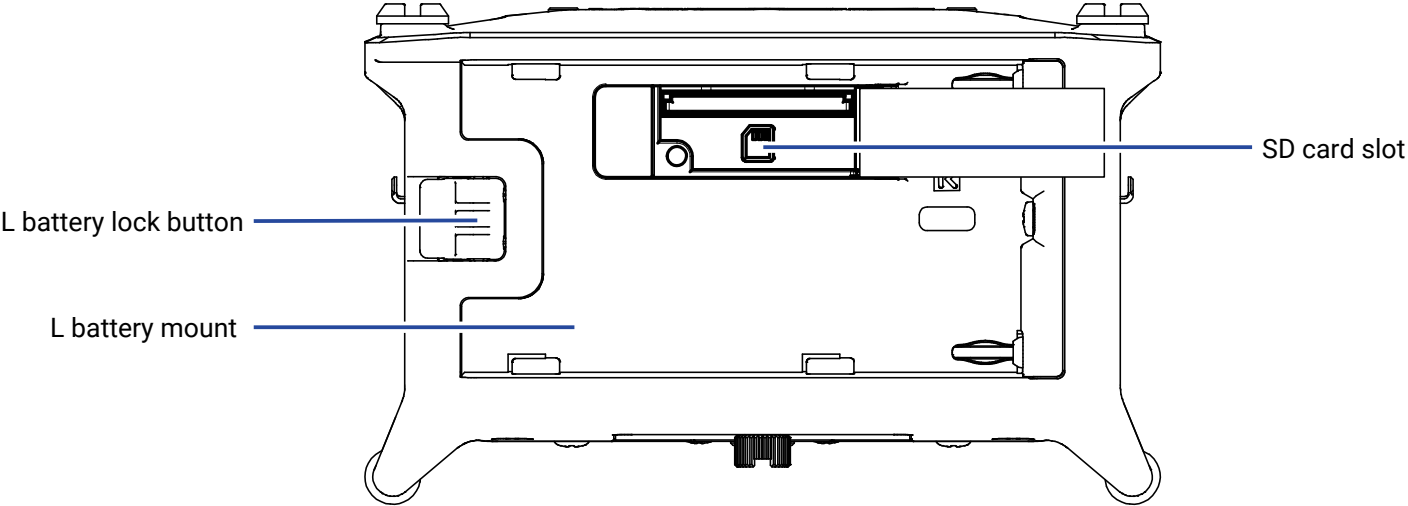

## Left side

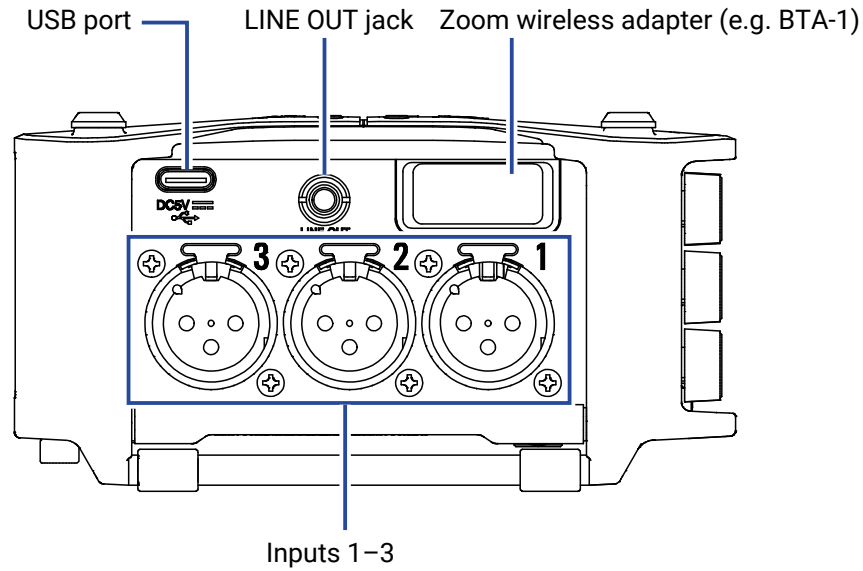

## Right side

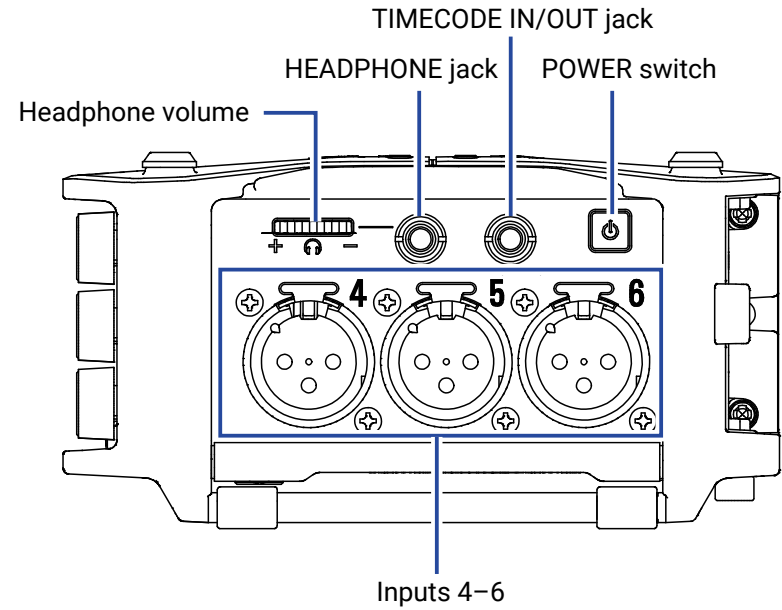

### Inputs 1-6

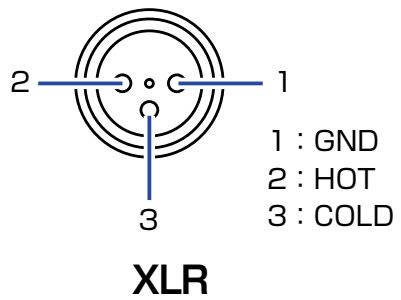

### TIMECODE IN/OUT

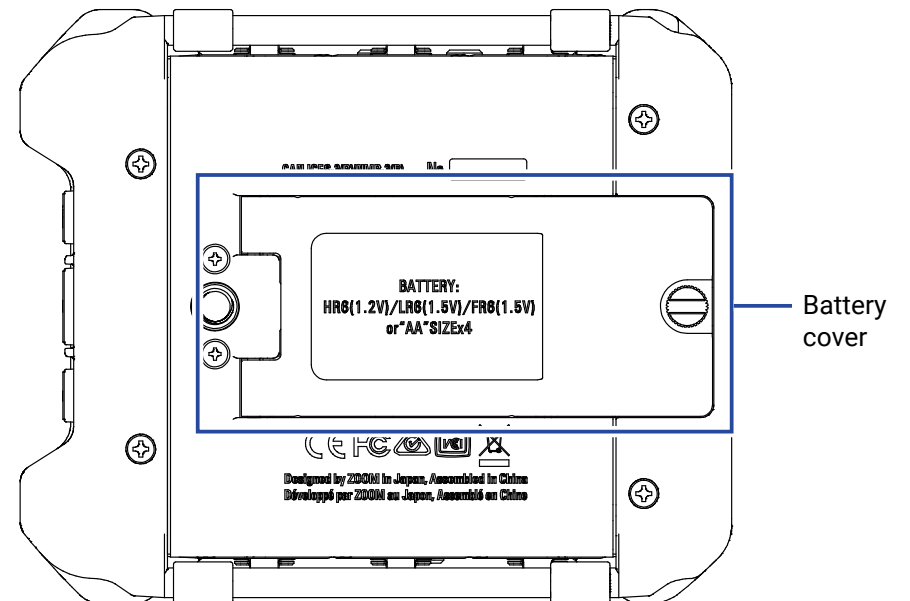
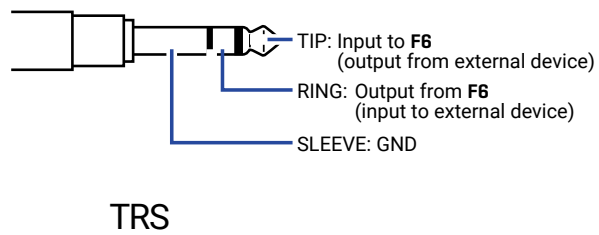

# Connecting mics/other devices to Inputs 1–6

The **F6** can record 6 individual tracks that correspond to Inputs 1–6 and a stereo mix of these inputs with left and right tracks.

Mics and the outputs of instruments and audiovisual equipment, for example, can be connected to Inputs 1–6 and recorded to tracks 1–6.

## Connecting mics

Connect dynamic and condenser mics with XLR plugs to Inputs 1–6.

Phantom power (+24 V/+48 V) can be supplied to condenser mics.

(→ P. 78)

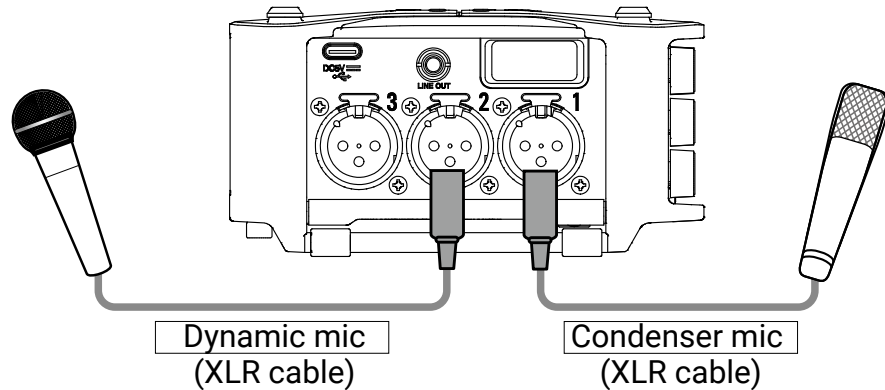

### NOTE

When disconnecting an XLR cable, pull the XLR plug while pushing the connector lock release button.

## Connecting line level equipment

Connect XLR cables from keyboards and mixers directly to Inputs 1–6.

Direct input of passive guitars and basses is not supported. Connect these instruments through a mixer or effects device.

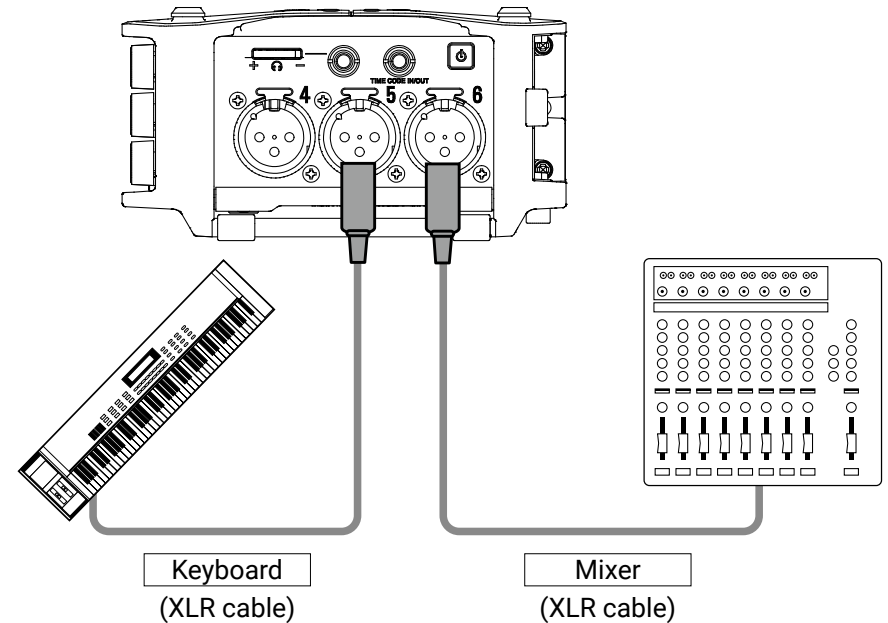



# Equipment connection examples

Recording is possible in a variety of situations like these.

## While filming

- Input 1: gun mic for main subject sound
- Inputs 2–4: lapel mics for performers
- Inputs 5–6: mics for ambient sound

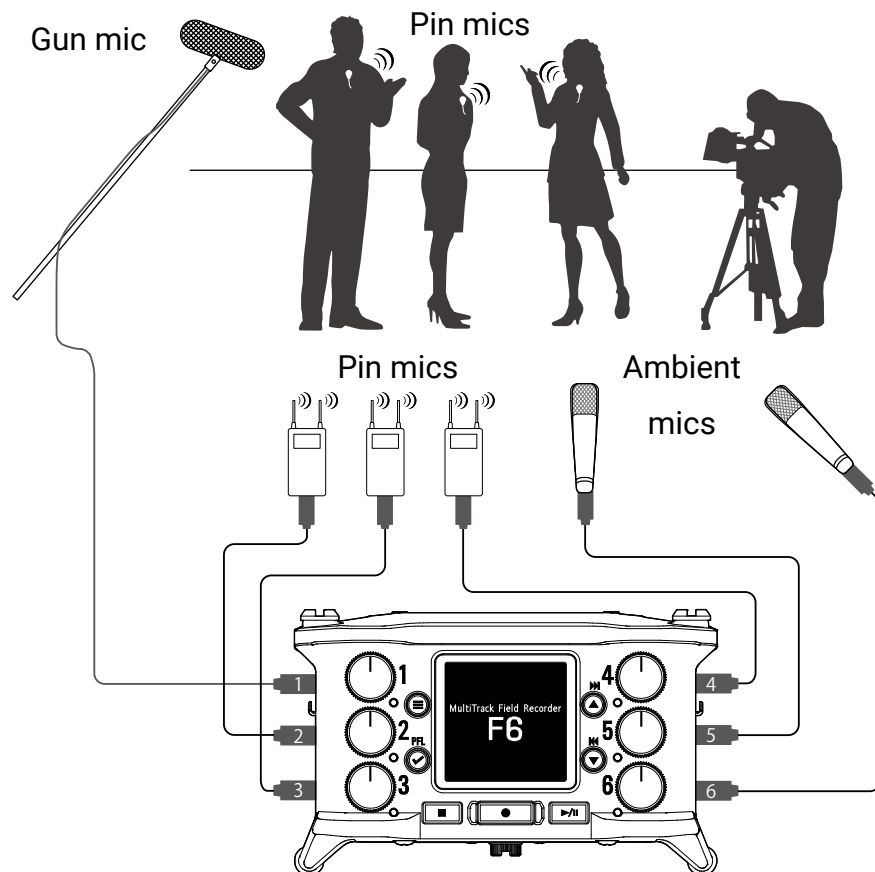

## Concert recording

- Inputs 1–2: line inputs for outputs from mixer
- Inputs 3–4: mics for stage performance
- Inputs 5–6: ambient mics for audience sound

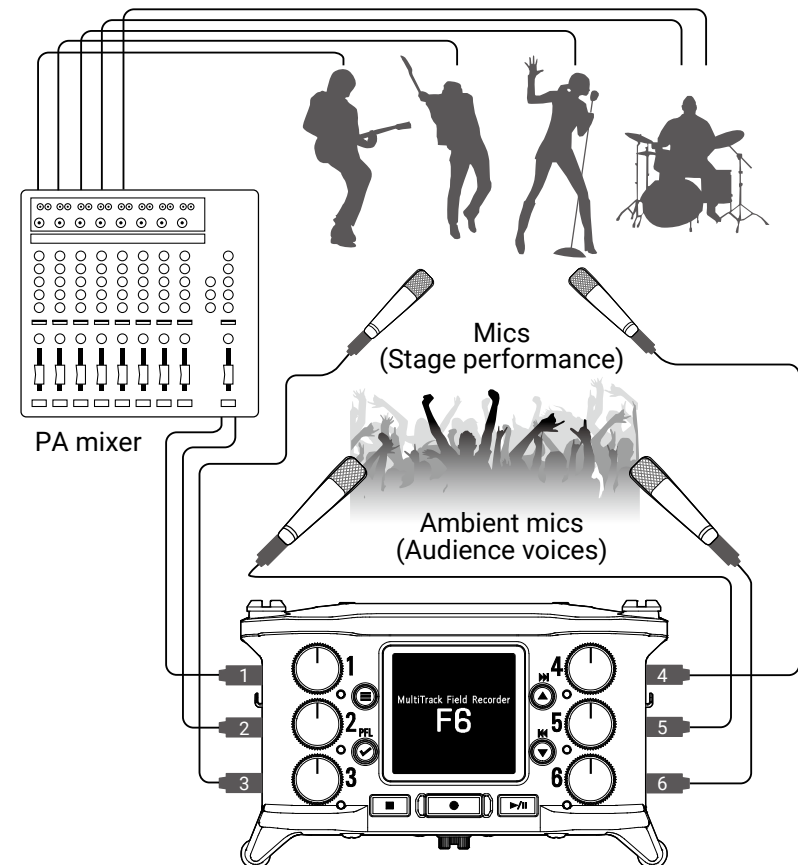

# Display overview

## ■ Home Screen

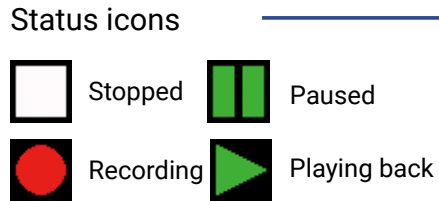

Counter  
 During recording: Elapsed/remaining recording time  
 During playback: Elapsed/remaining playback time

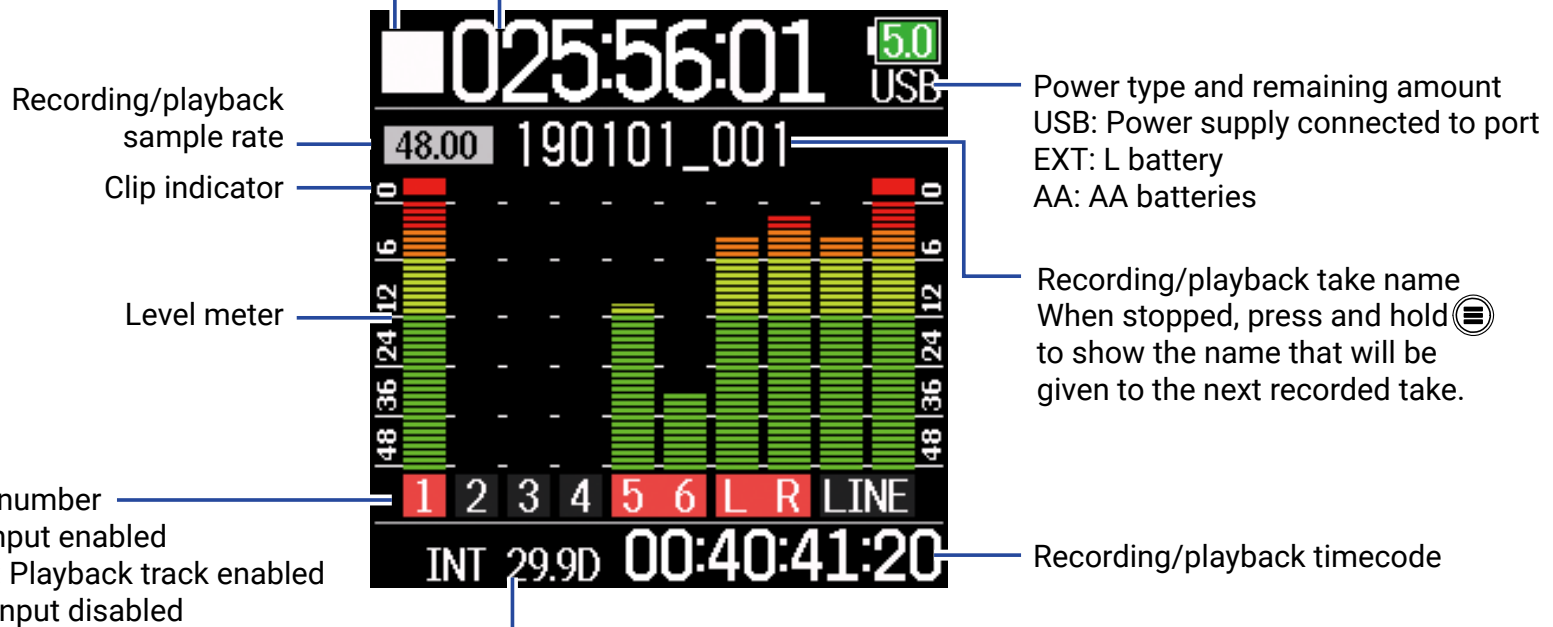

Input link settings are shown by connected adjacent track numbers.



Frame rate  
 INT: Internal timecode enabled  
 EXT: External timecode input enabled

### HINT

- When the Home Screen is not open, press and hold to return to the Home Screen.
- Some of the screen will appear differently when the recording mode is Float (32 bit).



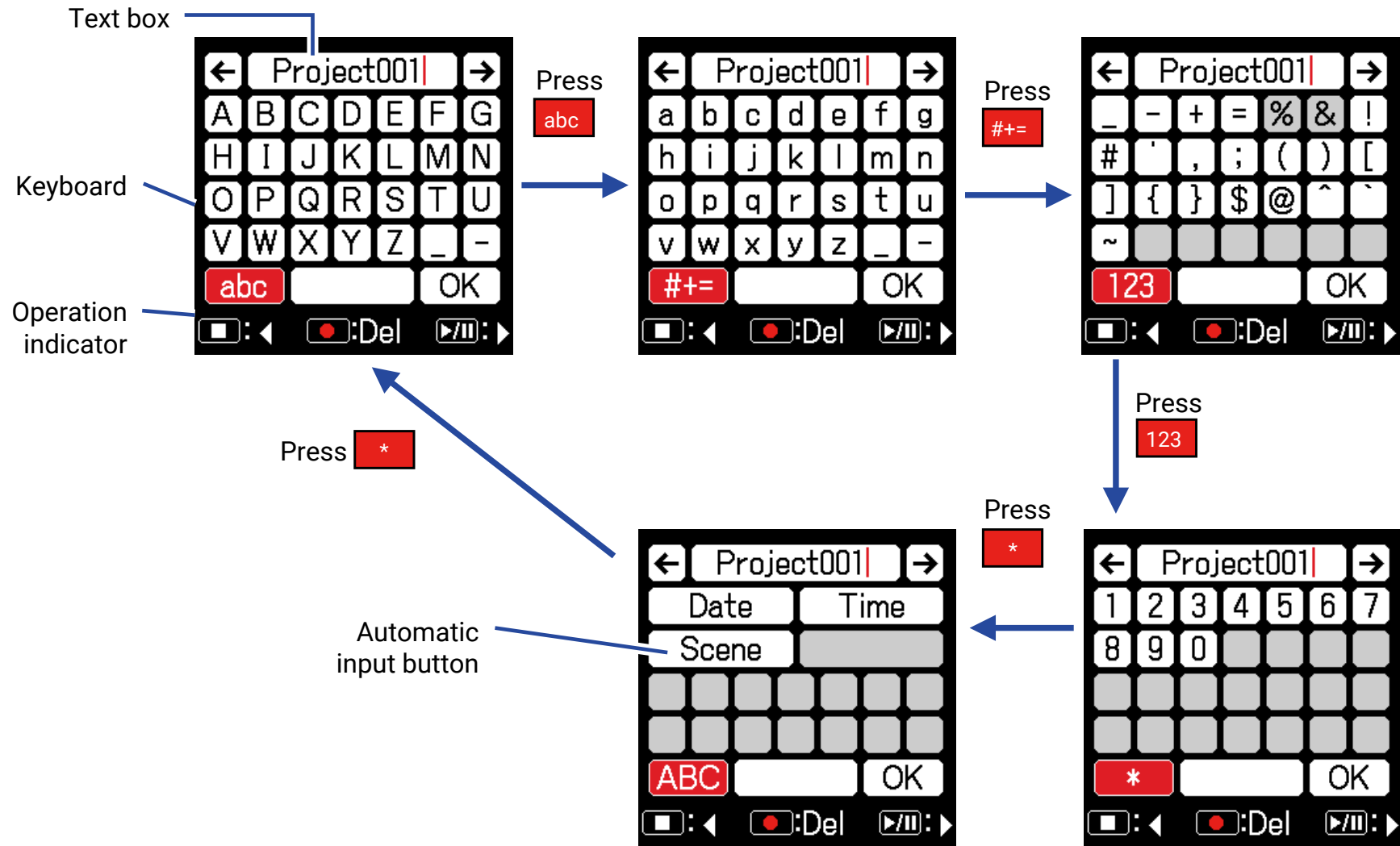





## Character input screen



### NOTE

- The following characters can be used in project names.
- (space) ! # \$ ' ( ) + , - 0 1 2 3 4 5 6 7 8 9 ; = @ A B C D E F G H I J K L M N O P Q R S T U V W X Y Z [ ] ^ \_ ` a b c d e f g h i j k l m n o p q r s t u v w x y z { }

## ■ Editing operations

Move cursor in text box	Use “ ← ” and “ → ” to move and press 
Select characters (vertical)	Press  or 
Select characters (horizontal)	Press  or 
Confirm characters	Move the cursor to the character to input, and press 
Delete characters	Move cursor before the character to delete in the text box, and press 
Complete editing	Move cursor to "OK" and press 
Cancel editing	Press 

## ■ Automatic input keys

(Date): This automatically inputs the date. Example: 190210

(Time): This automatically inputs the time. Example: 180950

(Scene): This automatically inputs the current scene name.

# Preparations

## Supplying power

Power can be supplied three ways using AA batteries, an L battery or USB.

### ■ Using AA batteries

1. Loosen the screw in the battery cover on the bottom.
2. Open the battery compartment cover on the bottom, remove the battery case, and insert 4 AA batteries.
3. Put the case into the compartment.
4. Close the battery cover and tighten the screw.

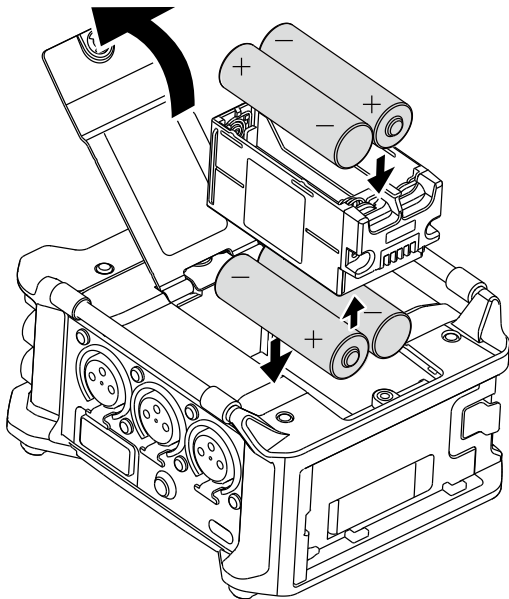

### ■ Using an L battery

1. Slide the battery in the direction of the arrow while pressing it toward the recorder.

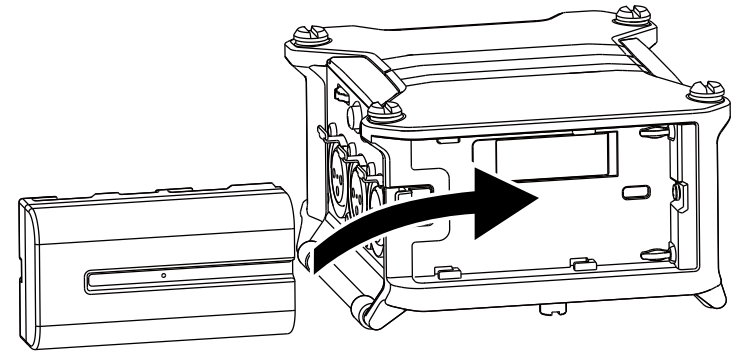

#### NOTE

- Be careful because the battery case could become loose unexpectedly if the battery compartment cover screw is not tightened firmly.
- Use only one type of batteries (alkaline, NiMH or lithium) at a time.
- After loading AA batteries, set "Power Source" to the correct type of battery. ( → P. 20)
- If the remaining battery power indicator becomes red, turn the power off immediately and install new batteries.

## ■ Using a USB Type-C cable

1. Connect the cable of the dedicated ZOOM AD-17 AC adapter to the USB port.
- 
2. Plug the dedicated AC adapter into an outlet.

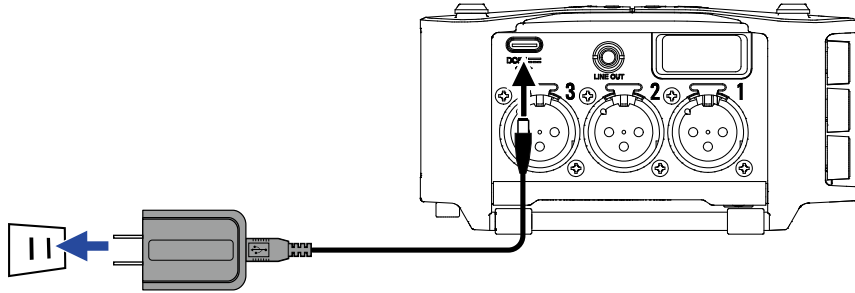

### NOTE

- A 5V mobile battery (commercially-available) can also be connected.
- When connected to a computer, power can be supplied by USB.

## Loading SD cards

1. Open the SD card slot cover, and insert an SD card.
2. To remove the card: push it further into the slot and then pull it out.

### NOTE

Before using SD cards that have just been purchased or that have been formatted on a computer, they must be formatted. To format an SD card, use Menu > SYSTEM > SD Card > Format.

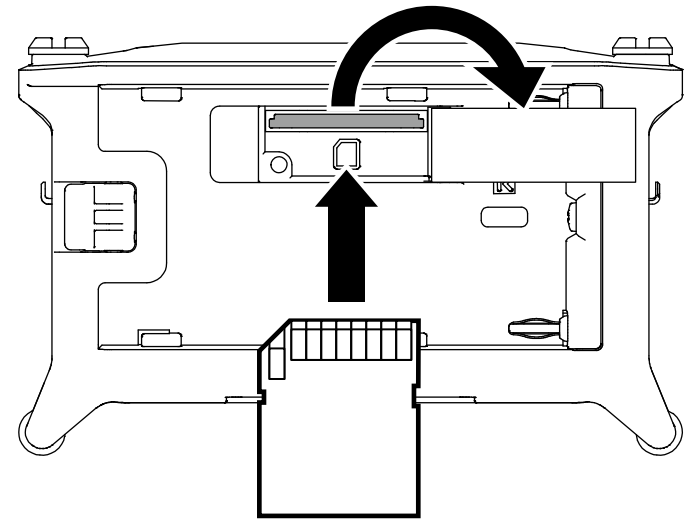

# Turning the power on and off

## ■ Turning the power on

1. Press and hold  briefly.

The ZOOM logo appears and the power turns on.

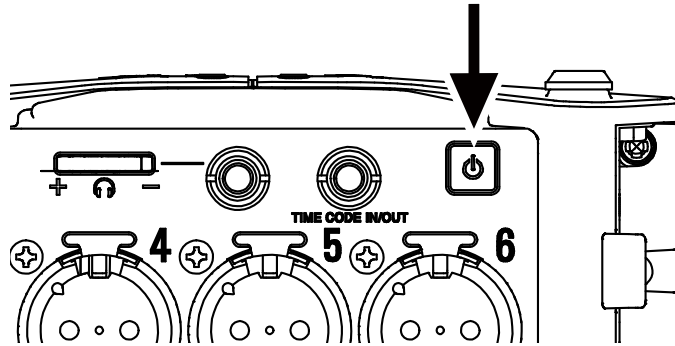

### NOTE

- The first time the power is turned on after purchase, the date/time must be set ( → P. 18). This setting can also be changed later.
- If “No Card!” appears on the display, confirm that an SD card is inserted properly.
- If “Card Protected!” appears on the display, the SD card write-protection is enabled. Slide the lock switch on the SD card to disable write-protection.
- If “Invalid Card!” appears on the display, the card is not formatted correctly. Format the card or use a different card. Formatting SD cards ( → P. 175)

## ■ Turning the power off

1. Press and hold  briefly.

### NOTE



Keep pressing it until the ZOOM logo appears on the LCD.







# Setting the language

The **F6** menu display language can be changed.

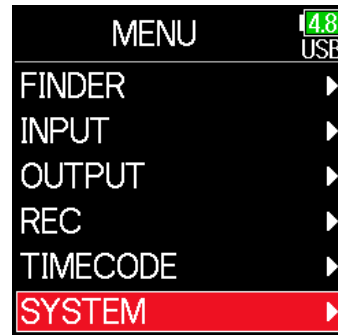

1. Press .

2. Use  and  to select SYSTEM, and press .

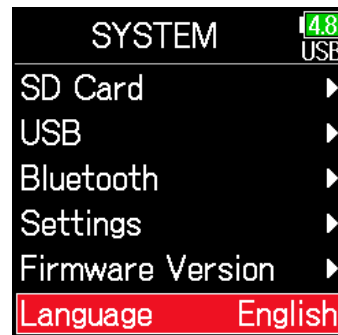

3. Use  and  to select Language, and press .



4. Use  and  to select the desired language, and press .





## NOTE

The first time the power is turned on after purchase, the language must be set.



# Setting the date and time

The date and time set on the **F6** are used when recording files, for example. The date format (order of year, month and day) can also be set.

1. Press .

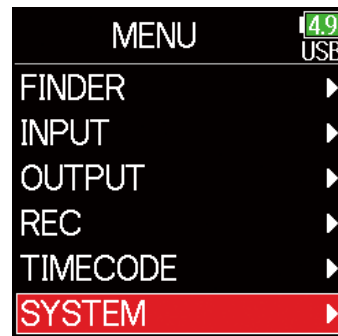
2. Use  and  to select SYSTEM, and press .



3. Use  and  to select Settings, and press .

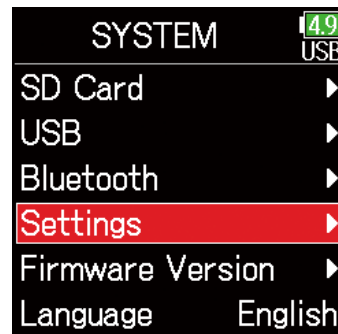

4. Use  and  to select Date/Time, and press .

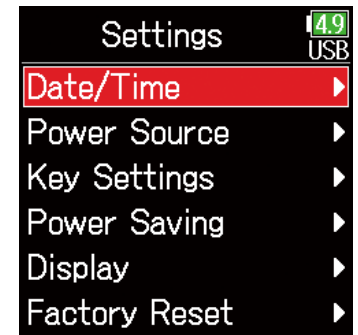

▶ Continue to one of the following procedures.

Setting the date and time .....	P. 19
Setting the date format .....	P. 19

## NOTE

The first time the power is turned on after purchase, the date/time must be set.

## ■ Setting the date and time

5. Use and to select Set Date/Time, and press .

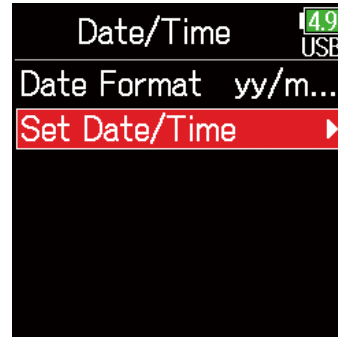

6. Set the date and time

Move cursor or change value:

Use and

Change item value:

Use and to select the item, and press .

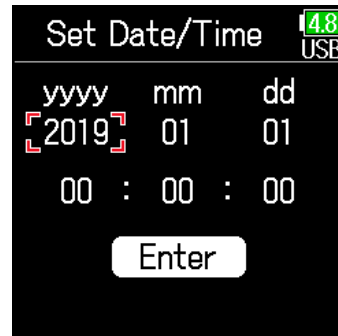

7. The item selected to be changed appears red.

Use and to change it, and press .

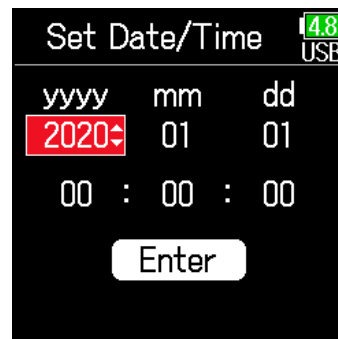

8. When done setting, use

and to select Enter, and press .

This completes setting the date and time.

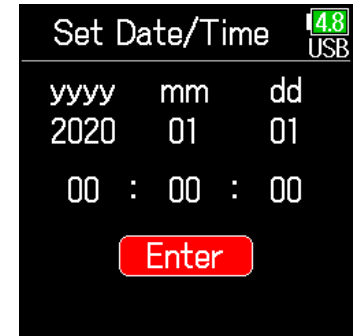

## ■ Setting the date format

5. Use and to select Date Format, and press .

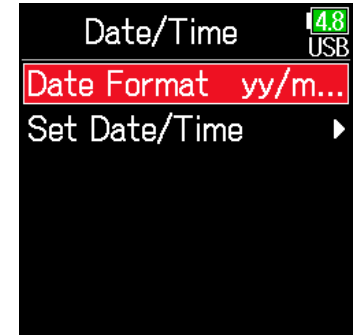

6. Use and to select the format, and press .

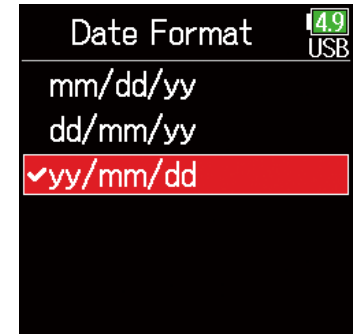



Setting	Explanation
mm/dd/yy	Month, day, year order
dd/mm/yy	Day, month, year order
yy/mm/dd	Year, month, day order



# Setting the power supply used

When using AA batteries, set the battery type so that the amount of remaining power can be shown accurately. The voltage of each power supply and the remaining battery charge can be checked on this menu page.

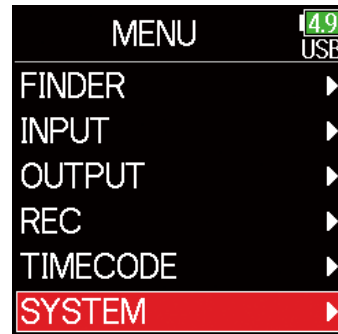

1. Press .

2. Use  and  to select SYSTEM, and press .



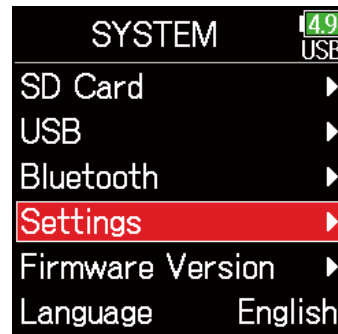

3. Use  and  to select Settings, and press .



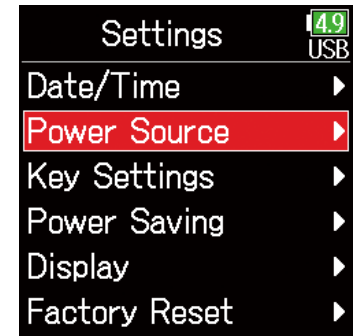



4. Use  and  to select Power Source, and press .

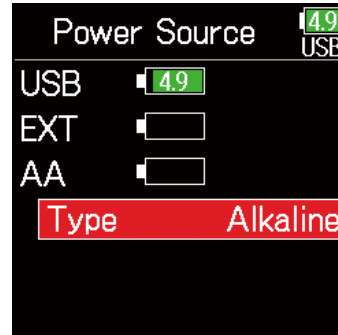

## ■ Setting the installed AA battery type

5. Use  and  to select Type, and press .



6. Use  and  to select the type, and press .

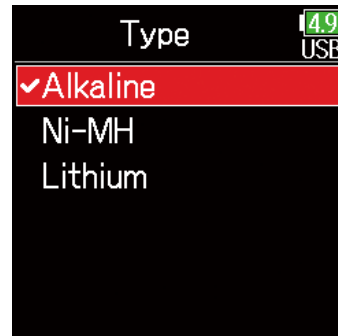

### NOTE

- When multiple power supplies are connected, they will be used in the following order of priority.
  1. USB (Power supply connected to USB port)
  2. EXT (L battery)
  3. AA (Installed AA batteries)
- The voltages of each power supply are shown on the display.

# Recording

## Recording process

Recording with the **F6** follows the process shown below.

The data created for each recording occurrence is called a "take".

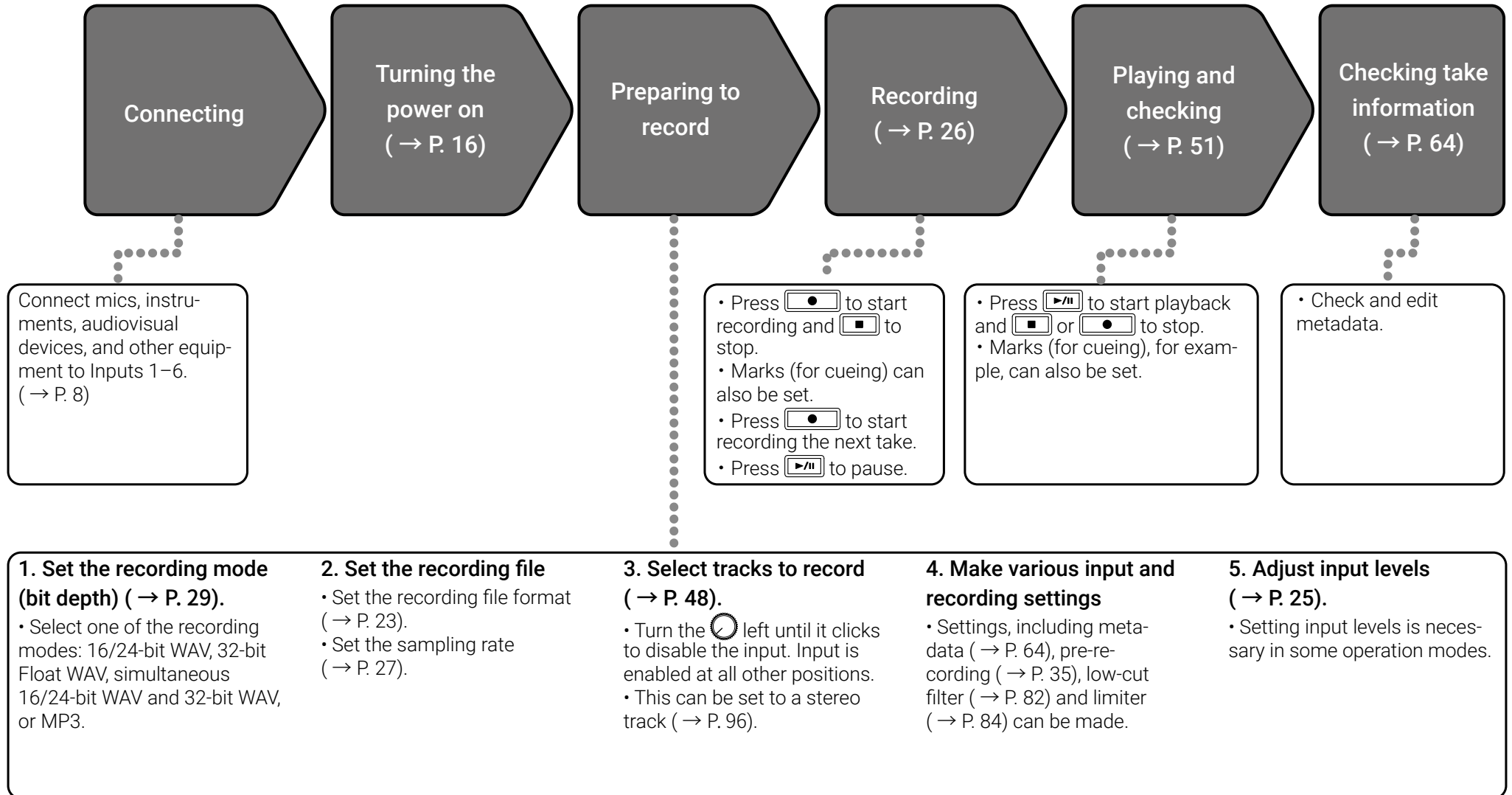



# Setting the recording file format

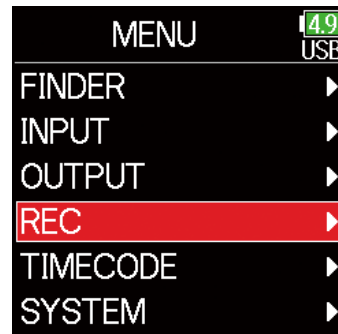

1. Press .

2. Use  and  to select REC, and press .

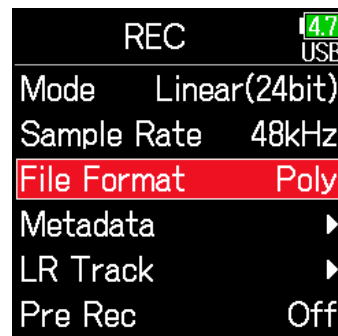

3. Use  and  to select File Format, and press .



4. Use  and  to select the file format, and press .

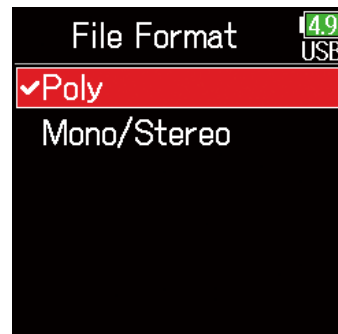

Setting	Tracks recorded	Explanation
Poly	Selected tracks 1-6	A single poly file will be created that contains audio for multiple tracks.
Mono/Stereo		A single mono file is created for each mono track and a single stereo file is created for each stereo track.

## NOTE

- When recording Mono/Stereo, audio files are saved in a folder that is created. ( → P. 40)
- This cannot be set when the mode is set to MP3.

# Selecting inputs and adjusting levels

Select which among Inputs 1–6 to use.

Inputs will be recorded on tracks with the same numbers. For example, Input 1 will be recorded on track 1 and Input 2 will be recorded on track 2.

## Selecting inputs

1. Turn  right for the number of an input to record, making the track status indicator light.

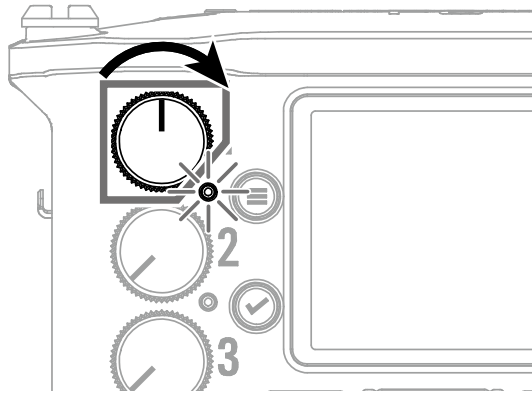

### HINT

Turn  left until it clicks to disable the input. Input is enabled at all other positions.

### NOTE



- The signals from the inputs selected this way will also be sent to the L/R tracks.
- The levels sent to the L/R tracks are adjusted with .

Track indicator	Track number background color	Explanation
Lit red	Red	The input is enabled.
Unlit	Gray	The input is disabled.



## ■ Adjusting input levels

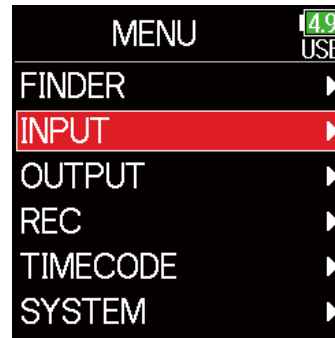

1. Press .

2. Use  and  to select INPUT, and press .



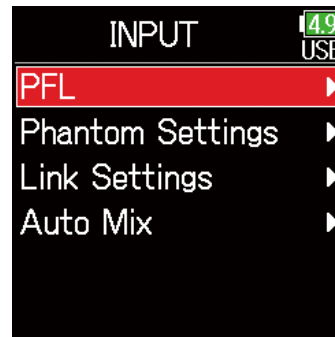

3. Use  and  to select PFL, and press .



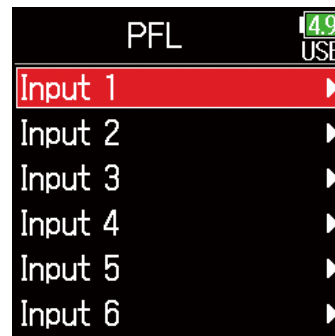

4. Use  and  to select the desired track, and press .

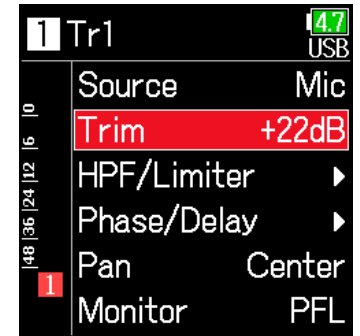

5. Use  and  to select Trim, and press .



6. Use  and  to adjust the input level, and press .

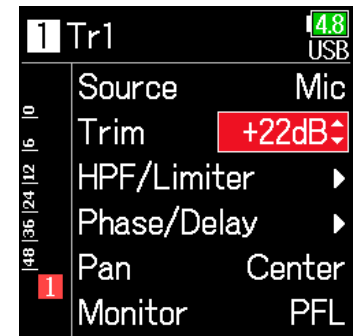

### HINT

- This can be set in a range from +12 to +75 dB when the input source is set to Mic, from -8 to +55 dB when set to Line, and from -35 to +30 dB when set to USB.
- If the sound distorts even after lowering the input level, try changing mic positions and adjusting the output levels of connected devices.
- Using the limiter (→ P. 84)
- Using the high pass filter (→ P. 82)

# Recording

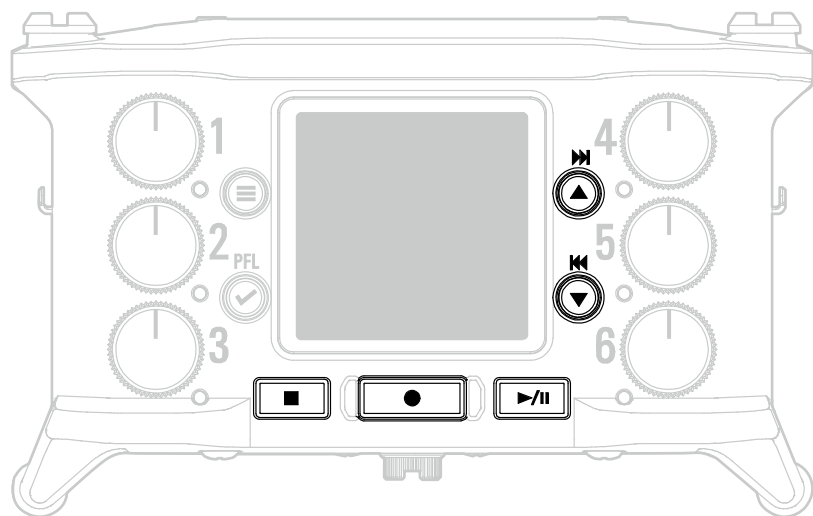

## 1. Press .

This starts recording.

### HINT

If the timecode function is enabled, recording will start from frame 00 (00 or 02 when using drop frame) and the file length will always be a full second value. This makes synchronization easy when editing later.

## 2. Press to start a new take when recording.

This will end the current take and start a new take while continuing to record without interruption.

### NOTE



Pressing  during recording is only possible after recording for at least a second.

## 3. Press to pause.

### NOTE

- Pausing occurs at whole second increments.
- When recording is paused, a mark is added at that point.
- Press  to resume recording.
- A maximum of 99 marks can be added to a take.

### HINT

- During playback,  and  can be pressed to jump to places where marks have been added.
- Marks can be added without pausing. ( → P. 167)

## 4. Press to stop.

### NOTE

If the file size exceeds 2GB during recording, a new take will be created automatically and recording will continue without interruption. No gap in sound will occur between the two takes when this happens.

### HINT

- Press and hold  when the Home Screen is open to check the name of the next take recorded.
- Files are automatically saved at regular intervals during recording. If the power is interrupted or another problem occurs during recording, an affected file can be restored to normal by playing it with the **F6**.



# Setting the sampling rate

The sampling rate used to record files can be set.

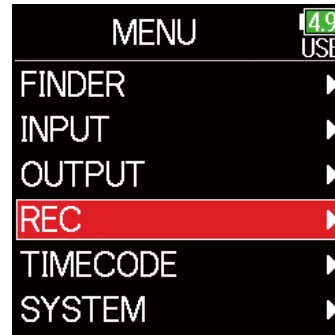

1. Press .

2. Use  and  to select REC, and press .

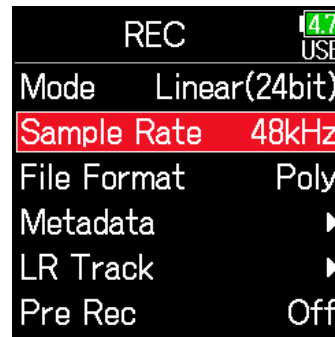

3. Use  and  to select Sample Rate, and press .



4. Use  and  to select the sampling rate, and press .

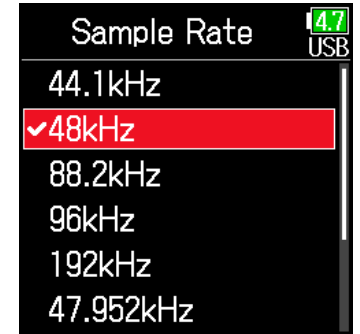

Setting	Explanation
44.1 kHz, 48 kHz, 88.2 kHz, 96 kHz, 192 kHz	These are standard sampling rates.
47.952 kHz	Select this when recording video at 23.976 frames per second in order to edit later at 24 frames per second.
48.048 kHz	Select this when recording video at 24 frames per second in order to edit later at NTSC 29.97 or 23.98 HD.
47.952 kHz(F), 48.048 kHz(F)	These function the same as the two above, but the sampling rate metadata will be recorded as 48 kHz for <FILE_SAMPLE_RATE>. This enables playback and editing with devices and software that do not support 47.952 kHz and 48.048 kHz WAV files. Playback, however, will occur at the $\pm 0.1\%$ speed at which the file was recorded.

**NOTE**



- 192 kHz cannot be selected when the recording mode is Float (32bit) and the LR track is on.
- When 192 kHz is selected, Dual (16+32bit) and Dual (24+32bit) cannot be set.
- When the recording mode is MP3, only 44.1 kHz and 48 kHz can be selected.
- When 192 kHz is selected, L/R tracks will not be recorded. Input and output delay are also disabled.
- The Limiter cannot be set to On (Advanced) if Auto Mix is On or the Ambisonic format is not set to Off.
- AIF with Rec cannot be used when values other than 44.1 kHz or 48 kHz are selected.

# Setting the recording mode (bit depth)



Set the recording mode.

The bit depth of WAV files recorded by the **F6** will change according to the mode setting.

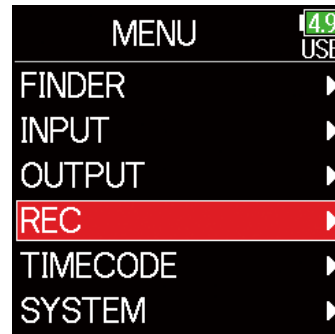

1. Press .

2. Use  and  to select REC, and press .

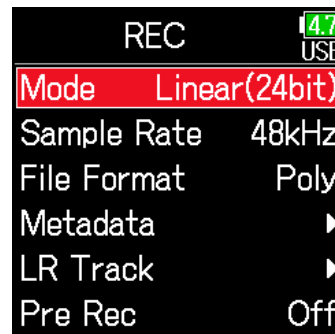

3. Use  and  to select Mode, and press .



4. Use  and  to select the mode, and press .

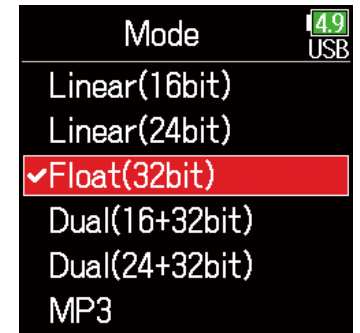

## HINT

The setting options are Linear (16bit), Linear (24bit), Float (32bit), Dual (16+32bit), Dual (24+32bit) and MP3.

Mode setting	Mode name	Explanation
Linear (16bit)	Linear	These modes record ordinary 16/24-bit WAV files. Adjust input (trim) levels so that the clip indicators do not light when recording. The level meters show input levels after adjustments.
Linear (24bit)		
Float (32bit)	Float	This mode records 32-bit float WAV files. Adjusting input levels is unnecessary. As long as maximum input levels are not exceeded, both quiet and loud sounds can be recorded with high quality. The level meters show levels after adjustments by  knobs.
Dual (16 + 32bit)	Dual	These modes simultaneously record ordinary 16/24-bit WAV files and 32-bit float WAV files. Adjust input (trim) levels so that the clip indicators do not light when recording. Even if clipping occurs in 16/24bit WAV file data during recording, data at a suitable level without clipping can be obtained by editing the 32bit Float WAV files during post-production.
Dual (24 + 32bit)		
MP3	MP3	This mode records MP3 files. Trim setting is necessary in this mode.



# Setting MP3 file bit rate (MP3)

The bit rate used for recording MP3 files can be set.

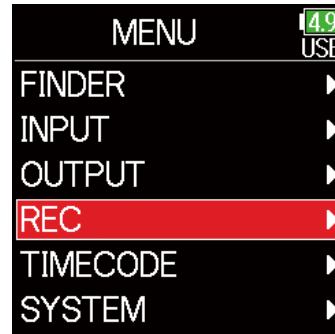

1. Press .

2. Use  and  to select REC, and press .

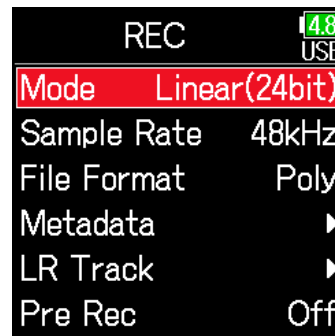

3. Use  and  to select Mode, and press .



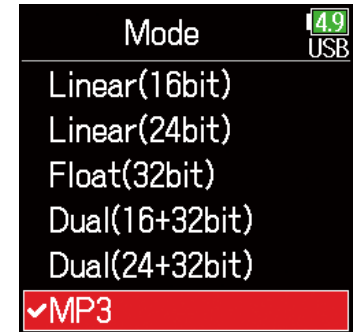

4. Use  and  to select MP3, and press .



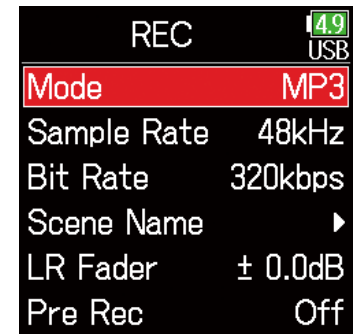

5. Press  to return to the REC screen.

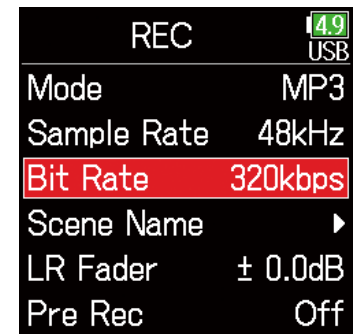

6. Confirm that the Mode is set to MP3. Then, use  and  to select Bit Rate, and press .



7. Use  and  to select the bit rate, and press .

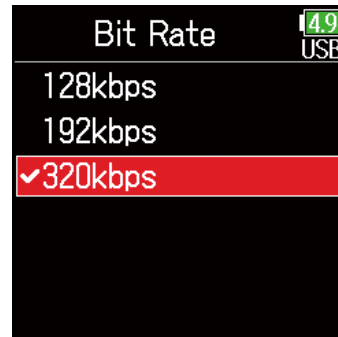

**HINT**

This can be set to 128 kbps, 192 kbps or 320 kbps.





# Setting the LR Track

## ■ Enabling the LR track

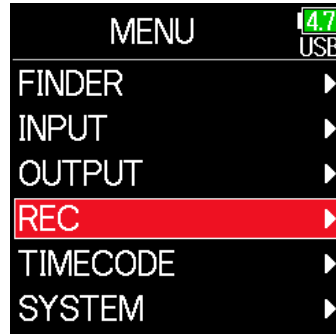

1. Press .

2. Use  and  to select REC, and press .



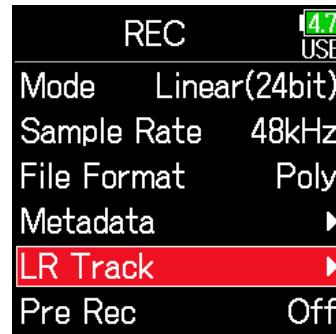

3. Use  and  to select LR Track, and press .

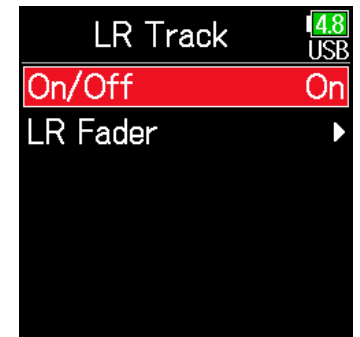

4. Use  and  to select On/Off, and press .



5. Use  and  to select On, and press .

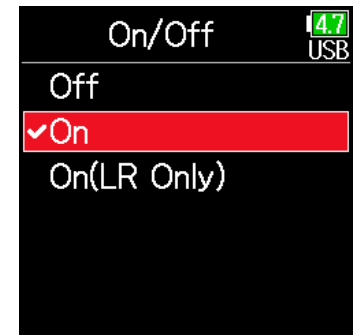





- NOTE
- Off: This disables the LR Track.
  - On: This enables the LR Track. All selected tracks and the LR Track will be recorded.
  - On (LR only): This enables the LR Track. Only the LR Track will be recorded.
  - On cannot be selected if the sample rate is 192 kHz or the recording mode is Float (32bit).

## ■ Adjusting the L/R track volume

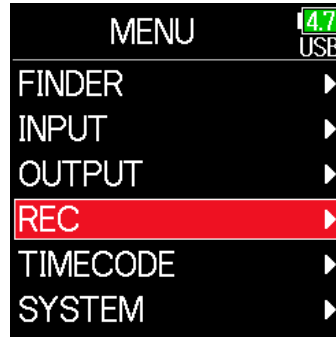

1. Press .

2. Use  and  to select REC, and press .



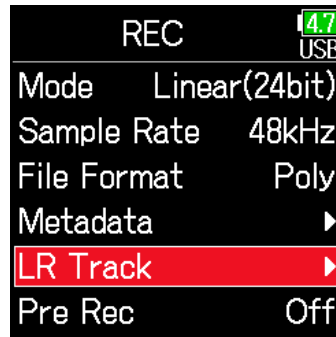

3. Use  and  to select LR Track, and press .



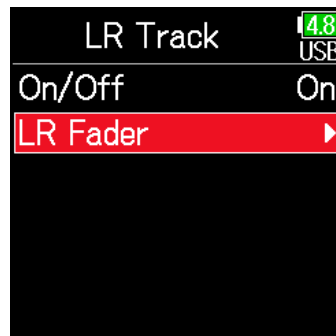

4. Use  and  to select LR Fader, and press .



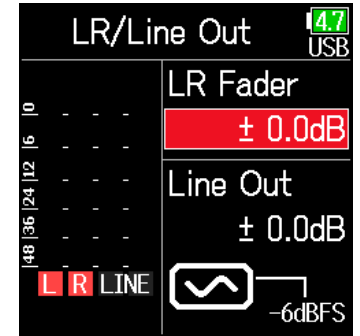

5. Use  and  to select LR Fader, and press .



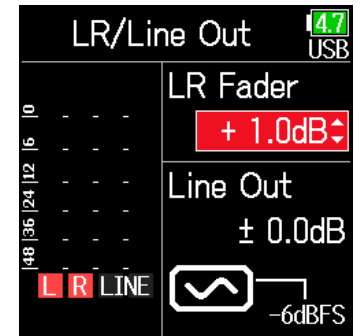

6. Use  and  to change the LR fader value, adjusting the LR track volume.



### NOTE

Pressing  +  when the Home Screen is open will also open the LR/Line Out setting screen.



# Capturing audio before recording starts

The input signal is always buffered for a set amount of time, so it can be captured for up to 6 seconds before  is pushed (pre-recording). This is useful when  is pressed late, for example.

1. Press .

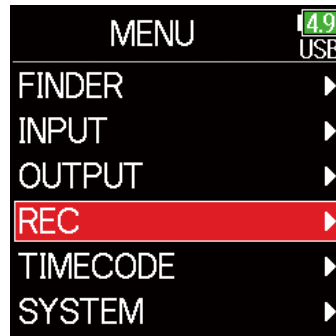
2. Use  and  to select REC, and press .



3. Use  and  to select Pre Rec, and press .

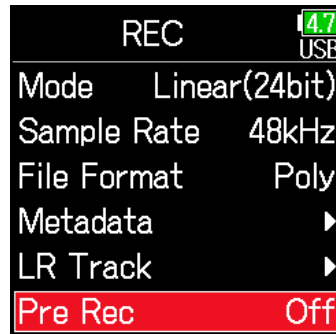

4. Use  and  to select On, and press .

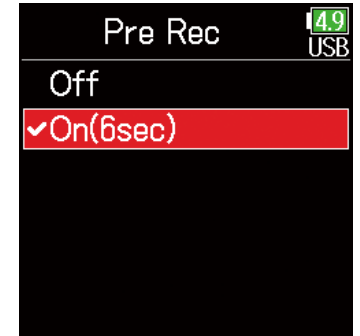

	Sample Rate	Maximum pre-recording time
WAV	44.1 kHz	6 seconds
	48 kHz	6 seconds
	88.2 kHz	3 seconds
	96 kHz	3 seconds
	192 kHz	1 second
	47.952 kHz	6 seconds
	47.952 (F) kHz	6 seconds
	48.048 kHz	6 seconds
	48.048 (F) kHz	6 seconds
MP3	44.1 kHz	6 seconds
	48 kHz	6 seconds



## NOTE

Pre-recording will be disabled if MENU > TIMECODE > Mode ( → P. 124) is set to Int Record Run, Ext or Ext Auto Rec.



# Setting the recording time display

During recording, either the elapsed recording time or the remaining possible recording time can be shown.

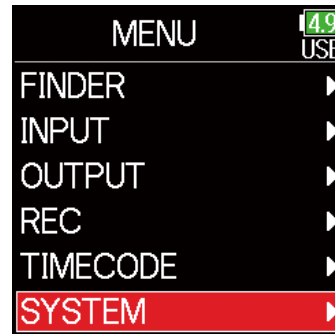

1. Press .

2. Use  and  to select SYSTEM, and press .



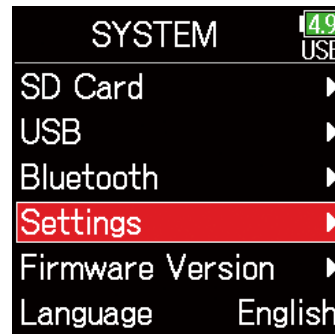

3. Use  and  to select Settings, and press .



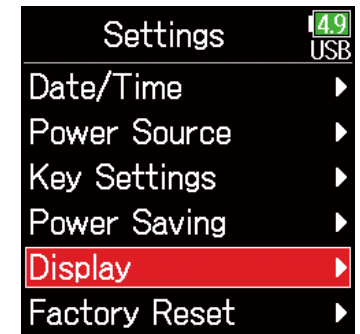

4. Use  and  to select Display, and press .



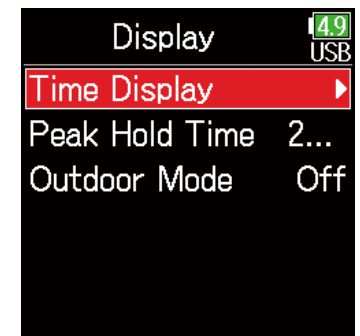

5. Use  and  to select Time Display, and press .



6. Use  and  to select Recording, and press .



7. Use  and  to select the time to show, and press .



#### NOTE

When recording for a long time, if the file size exceeds 2 GB, recording will continue in a new file and the recording time will reset. This can be changed, however, so that it is not reset and the total recording time is shown.

Set Rec Time Reset on the Time Display screen to On/Off to set whether or not recording time resets when a new file is created.

Off: When recording, even if the file size reaches 2GB, the counter shown on the Home Screen will not reset.



On (reset): When recording, if the file size reaches 2GB, the counter shown on the Home Screen will be reset to 000:00:00.







# Setting the playback time display

During playback, either the elapsed playback time or the remaining playback time can be shown.

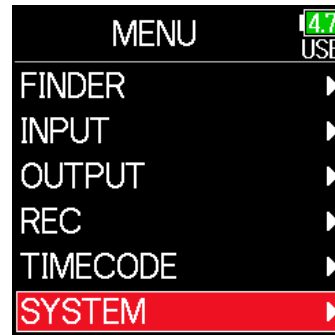

1. Press .

2. Use  and  to select SYSTEM, and press .



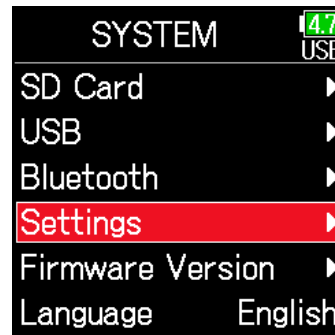

3. Use  and  to select Settings, and press .



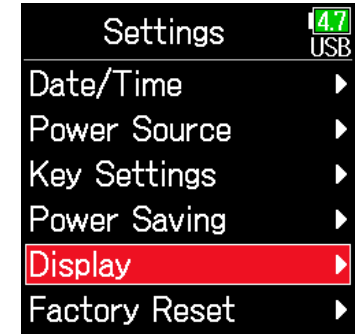

4. Use  and  to select Display, and press .



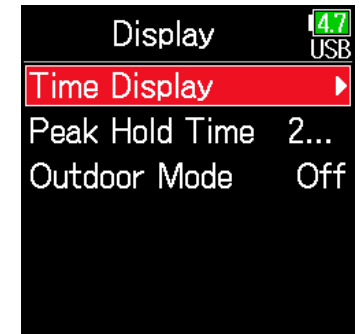

5. Use  and  to select Time Display, and press .



6. Use  and  to select Playing, and press .



7. Use  and  to select the time to show, and press .



# Folder and file structure

When recording with the **F6**, folders and files are created on the SD card in the following manner.

**F6** folders and files are used to manage scenes and takes as a rule.

## Folder and file structure

The folder and file structure differs according to the recording file format. In addition, the names of folders and files depend on how scenes are named.

### NOTE

- Setting the recording file format ( → P. 23)
- Setting how scenes are named (mode) ( → P. 45)

### HINT

Take: This is a unit of data created for a single recording.

Scene: This is a unit containing multiple files and takes that comprise a single scene.

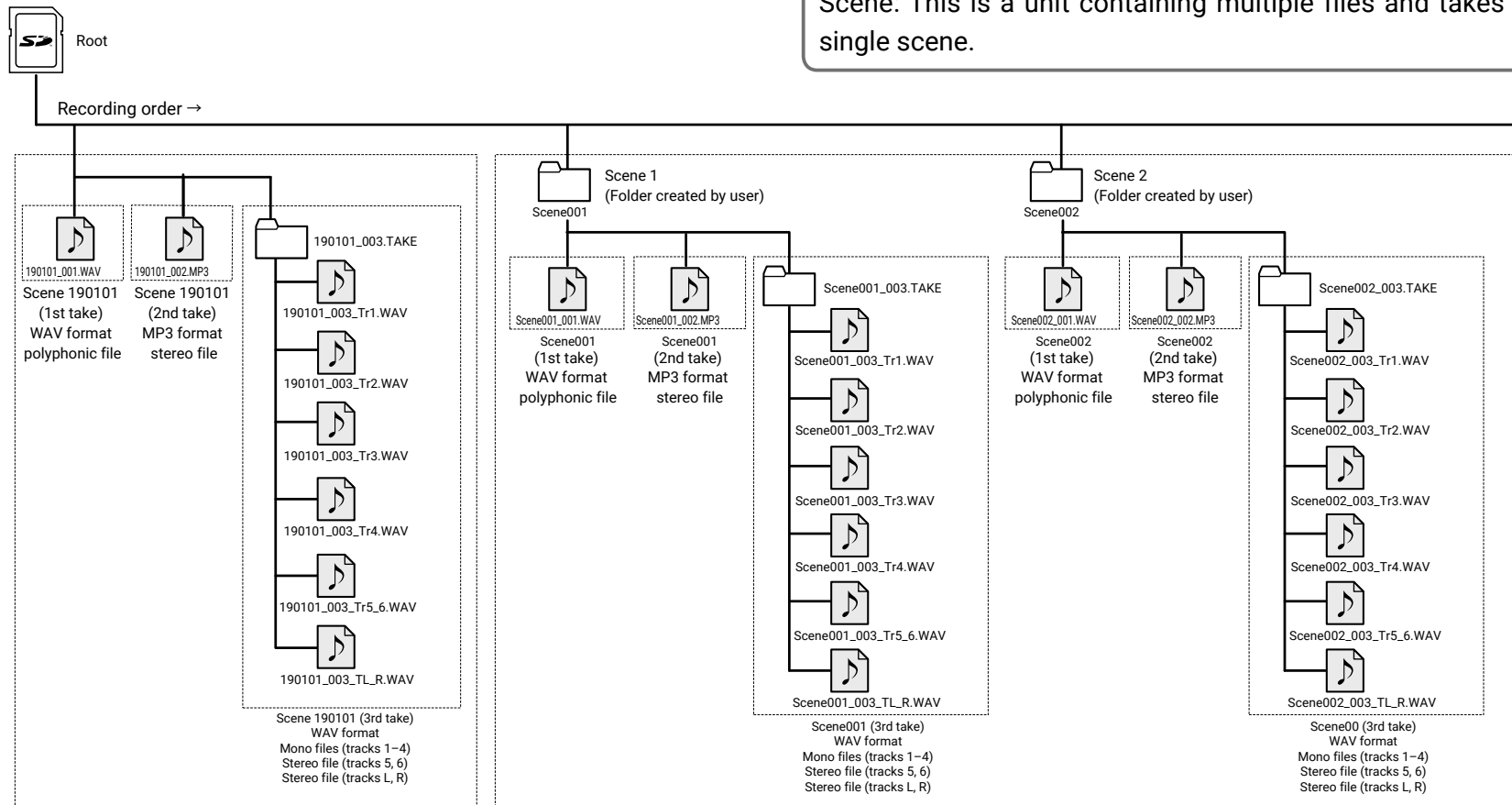

Recording when scene naming is set to "Date"

Recording when scene naming is set to "Current Folder"



## Take names

Structure	Explanation
<p>Scene001-001</p>	<p>Scene name: Select none, the folder name, the date or a name input by the user ( → P. 45).</p> <p>Scene number: Press  +  to increase the number by one.</p> <p>Take number: This number increases by 1 with each recording made with the same scene name and scene number.</p>

## Audio file names

File names given by the **F6** differ according to polyphonic, mono and stereo file formats. Track numbers and other data are added to file names.

### File names

File names are given according in the following formats.

Type	Structure	Explanation
Poly file	<p>Scene001-001.wav</p>	This is a file created by polyphonic recording. Audio for multiple tracks is recorded to a single file.
Mono file	<p>Scene001-001_Tr1.wav</p>	This is a file created by monophonic recording.
Stereo file	<p>Scene001-001_Tr1_2.wav</p>	This is a file created by stereophonic recording.
Float file in Dual mode	<p>Scene001_001_32FP.wav</p>	This is a 32bit Float WAV file created when in Dual recording mode.
Long recording file	<p>Scene001_001_0002.wav</p>	This is a file created automatically when the file size exceeded 2 GB during recording. The long recording file number increases one each time the file changes.

### HINT

When recording with a Mono/Stereo setting, the audio files are saved in a take folder that is created.

# Move the previously recorded take to the FALSE TAKE folder.

If the just recorded take was a failure, a shortcut can be used to move the recording to the FALSE TAKE folder.

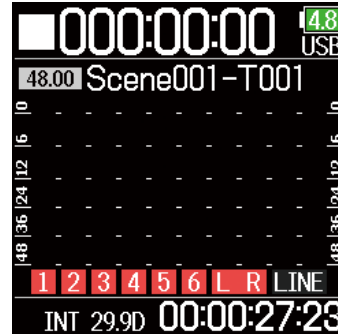

1. Open the Home Screen.



2. While pressing , press .

## HINT

- Moving a take to the FALSE TAKE folder reduces the take number by one.
- Even during recording, the previously recorded take can be moved to the FALSE TAKE folder.

3. Use  and  to select Execute, and press .

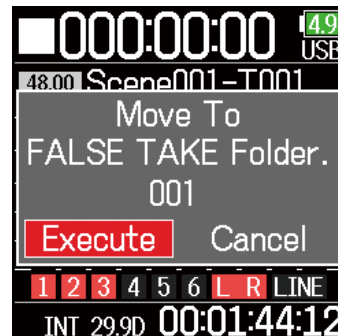

# Recorded take settings

## Changing the note for the next take recorded

Characters can be input, for example, as a note to use as metadata in files.

1. Press .

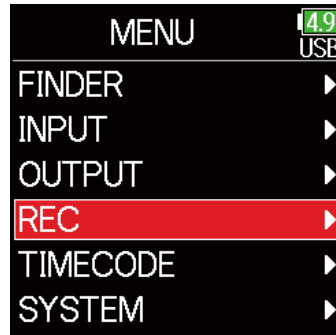

2. Use  and  to select REC, and press .



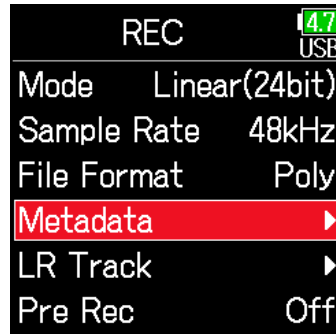



3. Use  and  to select Metadata, and press .

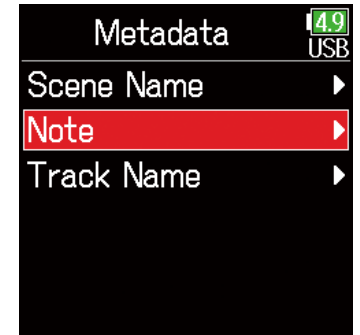

### ■ Editing notes

4. Use  and  to select Note, and press .



5. Use  and  to select Edit, and press .

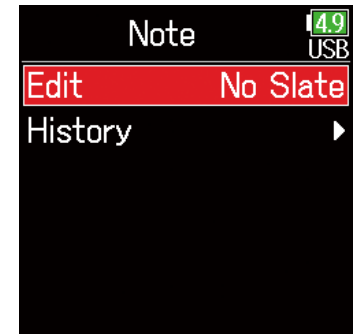

► Continue to one of the following procedures.

Editing notes .....	P. 43
Selecting notes from the history list .....	P. 44

## 6. Edit the note.

See "Character input screen" (→ P. 11) for how to input characters.



### NOTE

This note is written to the <NOTE> metadata.

## ■ Selecting notes from the history list

5. Use and to select History, and press .

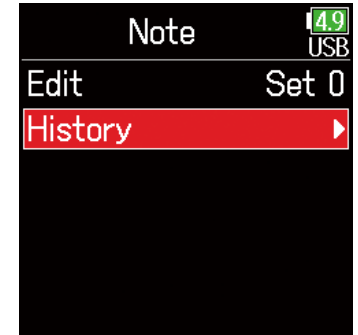

6. Use and to select the desired history item, and press .



### NOTE

The history list will be erased if the Factory Reset function is used.



# Setting and managing recorded scene names

The way scenes are named (name mode) can be set.

1. Press .

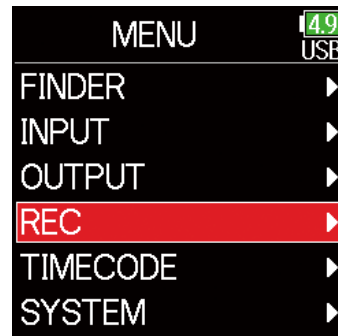

2. Use  and  to select REC, and press .



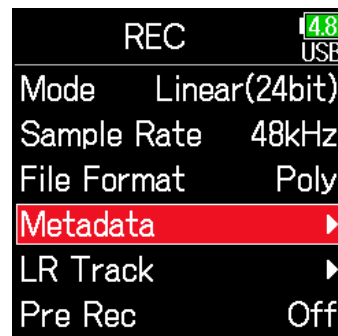



3. Use  and  to select Metadata, and press .

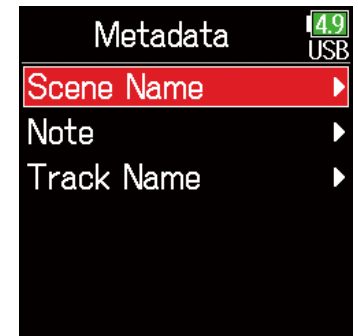

Setting how scenes are named (mode)

4. Use  and  to select Scene Name, and press .



5. Use  and  to select Mode, and press .

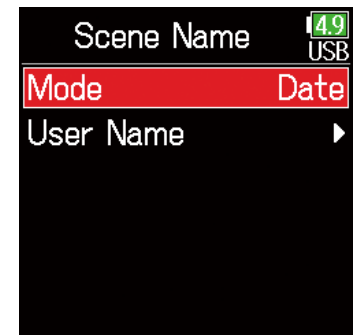

▶ Continue to one of the following procedures.

Setting how scenes are named (mode) .....	P. 45
Changing scene names .....	P. 46
Selecting a scene name from the history list .....	P. 47

Setting	Explanation
Current Folder	The name of the currently selected folder is used as the scene name. ⏮ + ⏹ can be used to advance the scene number by 1. After advancing the scene number by 1, the corresponding folder will be used as the recording destination. If that folder does not already exist, it will be created. Example: FOLDER001-001.wav
Date	The date is used as the scene name. ⏮ + ⏹ cannot be used to advance the scene number by 1. Example: 20190101-001.wav
User Name	A scene name input by the user is used. ⏮ + ⏹ can be used to advance the scene number by 1. Example: MYSCENE001-001.wav

## ■ Changing scene names

If Scene Name Mode is set to User Name, set the scene name used like this.

4. Use ⏮ and ⏭ to select User Name, and press ⏹.

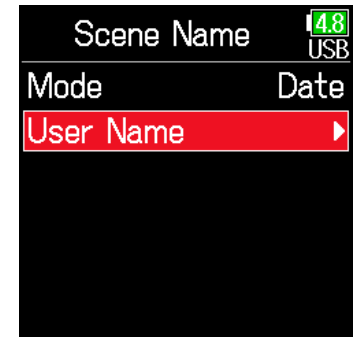

5. Use ⏮ and ⏭ to select Edit, and press ⏹.



6. Edit the scene name.

See "Character input screen" (→ P. 11) for how to input characters.



**NOTE**

- The scene name is written to the <SCENE> metadata.
- Spaces and @ marks cannot be input at name beginnings.

**■ Selecting a scene name from the history list**

4. Use ▲ and ▼ to select User Name, and press ✓.

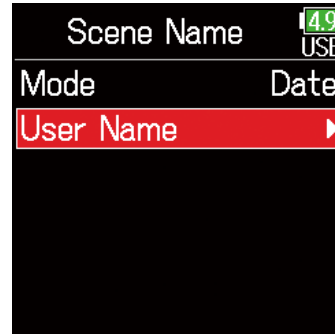

5. Use ▲ and ▼ to select History, and press ✓.

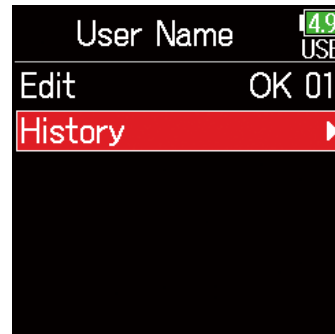

6. Use ▲ and ▼ to select the desired history item, and press ✓.



**NOTE**

The history list will be erased if the Factory Reset function is used.

# Changing the track name of the next take recorded (Track Name)

The track name set with the following procedure will be given to the next recorded track.

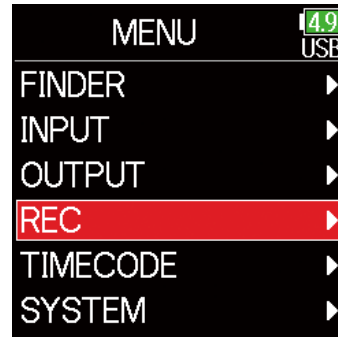

1. Press .

2. Use  and  to select REC, and press .



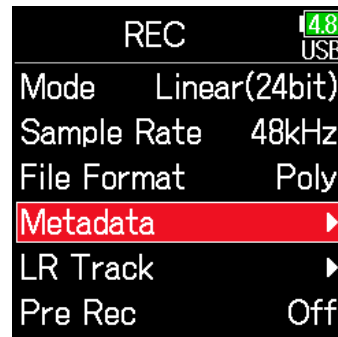

3. Use  and  to select Metadata, and press .

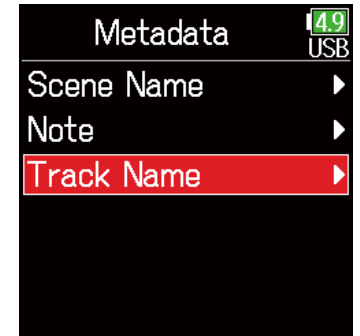

4. Use  and  to select Track Name, and press .



5. Use  and  to select a track, and press .



▶ Continue to one of the following procedures.

Editing the track name ..... P. 49

Selecting a track name from the history list ..... P. 49



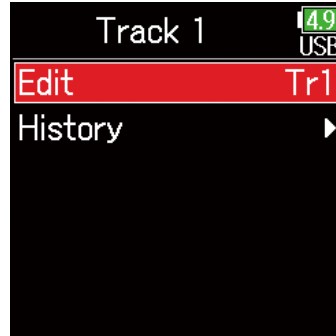

## ■ Editing the track name.

6. Use  and  to select Edit, and press .



## ■ Selecting a track name from the history list

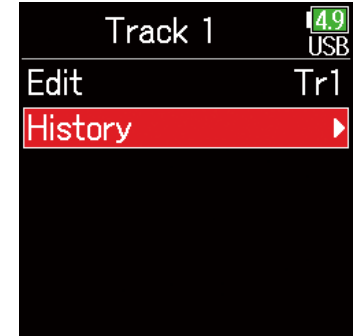

6. Use  and  to select History, and press .

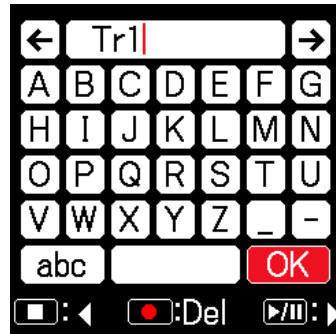

7. Edit the track name.

See "Character input screen" (→ P. 11) for how to input characters.



7. Use  and  to select the desired history item, and press .

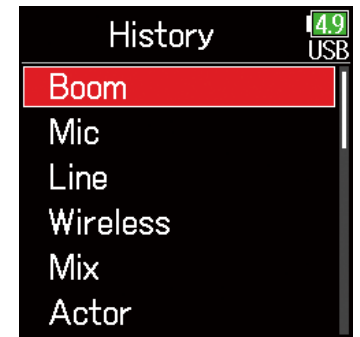

### NOTE

The track name is written to the <TRACK> <NAME> metadata.



### NOTE

The history list will be erased if the Factory Reset function is used.

# Changing the number of the next take recorded

The number given to the next recorded take can be changed when the Home Screen is open.

1. While pressing , press .

2. Use  or  to increase or decrease the take number, and press .

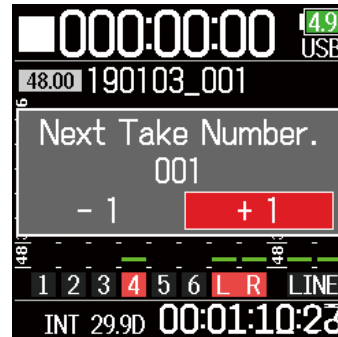

## NOTE

This function cannot be used during recording and playback or when the Scene Name Mode is set to Date. How scenes are named can be changed with the following menu item.

MENU > Metadata > Scene Name > Mode



# Playback

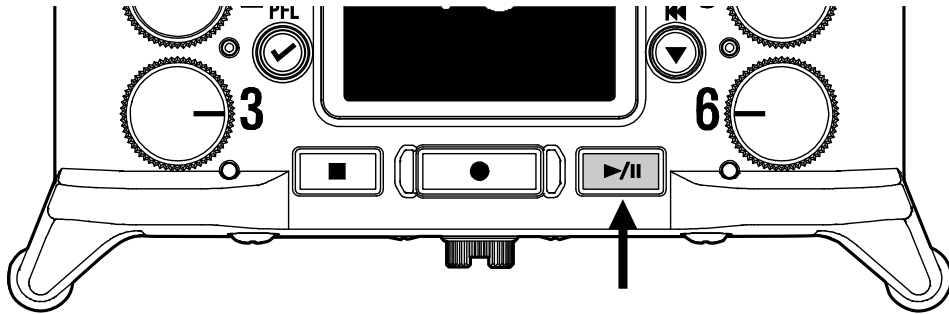

## Playing recordings



1. Press .



### ■ Playback operations

Select take/Jump to mark: Press  / 

Search backward/forward: Press and hold  / 

Pause/resume playback: Press 

### HINT

- The longer  /  is pressed and held, the faster the speed of searching backward/forward.
- An "Invalid Take!" message will appear if the selected take is not valid.
- A "No Take!" message will appear if no playable take exists.
- During playback, press  to add marks that can be used for skipping. (→ P. 167)

2. Press  to return to the Home Screen.

### NOTE

Track backgrounds will appear black.

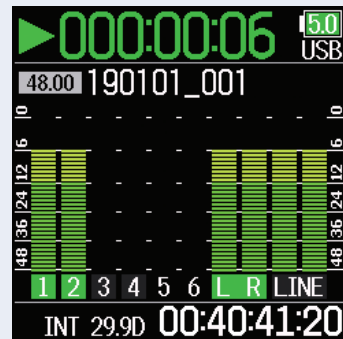

# Mixing takes

The volume and panning of each track during playback can be changed.

## ■ Setting faders

1. Touch  on the Home Screen (→ P. 10).

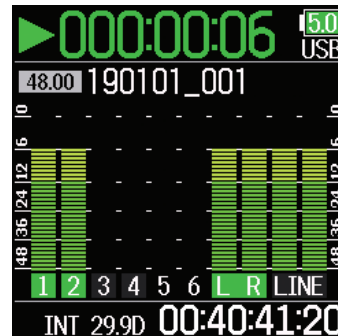

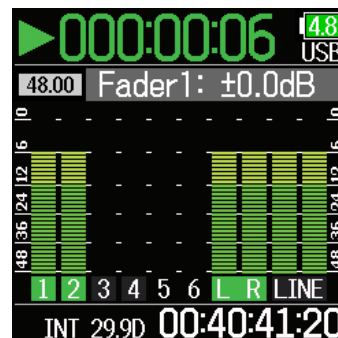

2. Turn  to adjust the input signal level.







### NOTE

Turn  left until it clicks to mute the input.

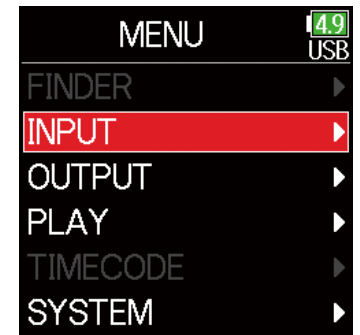

## ■ Setting the panning

1. Press .
2. Use  and  to select INPUT, and press .



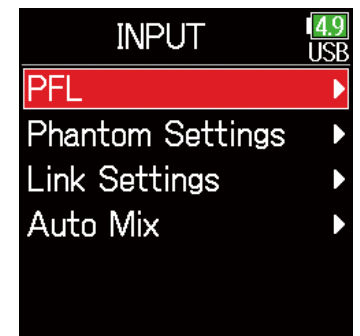

3. Use  and  to select PFL, and press .

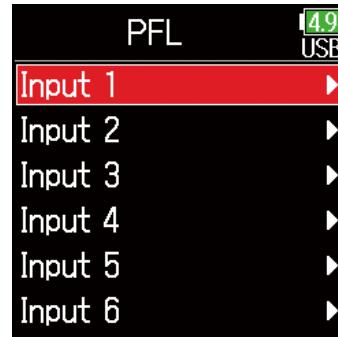

5. Use  and  to select the desired track, and press .



6. Use  and  to select Pan, and press .

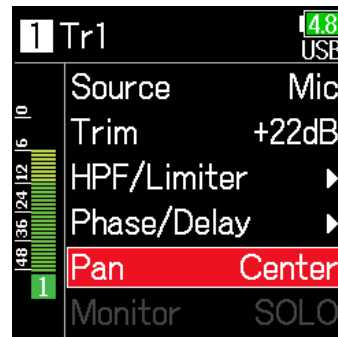

7. Adjust the panning.

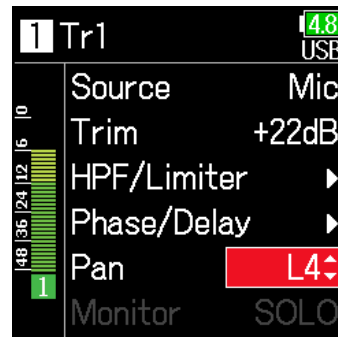

Parameter	Setting range	Explanation
Fader (in Float mode)	Mute, -48.0 – +24.0 dB	Adjusts the input signal level.
Fader (in Linear mode)	Mute, -60.0 – +60.0 dB	
Pan	L100 – Center – R100	Adjusts the stereo balance of the sound.

**NOTE**

- Settings are saved separately for each take and are used during playback.
- Mix settings are not saved with the take when the recorded file format is MP3.

# Monitoring the playback signals of specific tracks during playback

The playback signals of specific tracks can be monitored using SOLO mode.

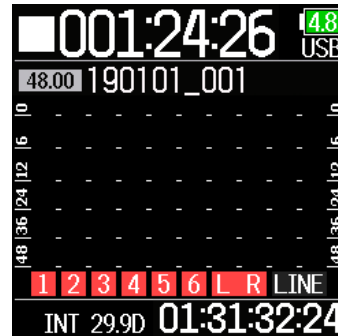

1. Open the Home Screen.

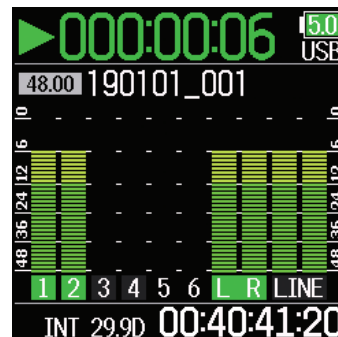

2. Press  to start playback.



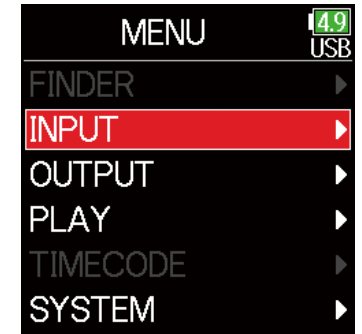

3. Press  during playback.

4. Use  and  to select INPUT, and press .



## NOTE

SOLO mode can only be used with tracks that can be played back (indicators lit green).

5. Use  and  to select PFL, and press .

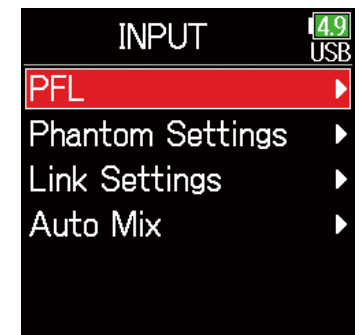

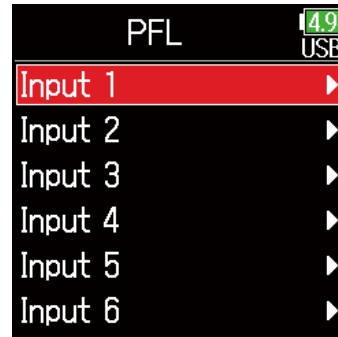

6. Use  and  to select the track to monitor, and press .







# Changing the repeat playback setting

The repeat setting used during playback can be changed.

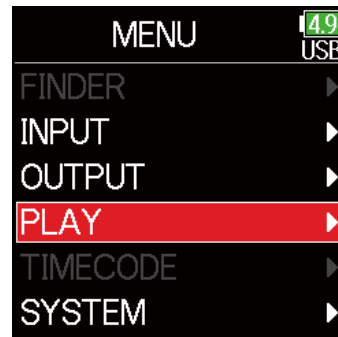

1. Press .

2. Use  and  to select PLAY, and press .

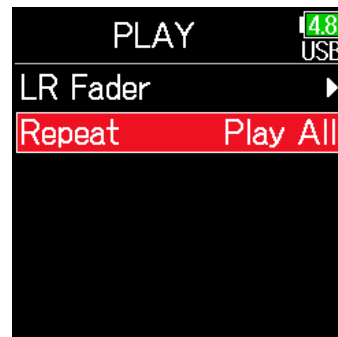

3. Use  and  to select Repeat, and press .



4. Use  and  to select the repeat mode, and press .

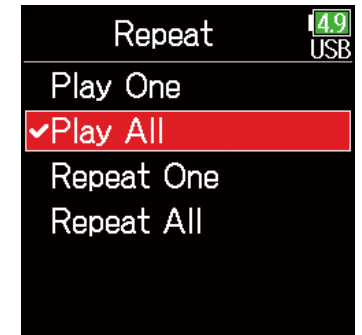

Setting	Explanation
Play One (single playback)	Only the selected take will be played.
Play All (all playback)	Takes will be played back continuously from the selected one until the last one.
Repeat One (single repeat playback)	The selected take will be played repeatedly.
Repeat All (all repeat playback)	All takes in the selected folder will be played repeatedly.





# Take and folder operations



## Working with takes and folders

The Finder allows the viewing of the contents of SD cards, takes and folders and the creation of project/scene folders. It also allows the setting and deletion of recording/playback folders along with viewing their information, for example.

1. Press .

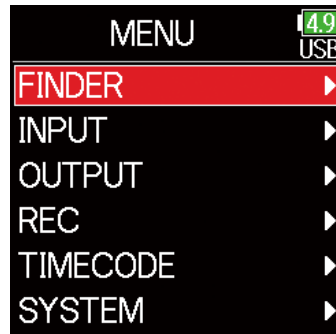
2. Use  and  to select FINDER, and press .



3. Use  and  to select the SD card, and press .

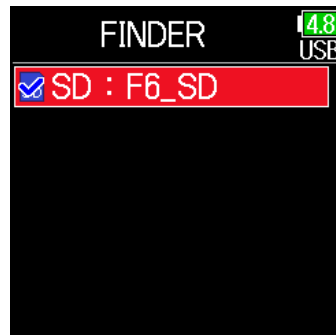

### ■ Editing operations





Cursor: Press  / 

Move down a level (next): Press 

Move up a level (previous): Press 

Show Option screen: Press and hold 

### NOTE



- When the cursor is on a take, pressing  will play the selected take.    and  can also be used.
- A check mark appears on the playback take and recording/playback folder.

### ► Continue to one of the following procedures.

Creating folders .....	P. 58
Selecting the take recording/playback folder .....	P. 58
Checking take marks and using them for playback .....	P. 59
Changing folder and take names .....	P. 59
Deleting folders and takes .....	P. 60
Emptying the TRASH/FALSE TAKE folders .....	P. 61

## ■ Creating folders

Folders can be created inside the currently selected SD card/folder.

5. Use  and  to select New Folder, and press .



6. Edit the folder name.

See "Character input screen" (→ P. 11) for how to input characters.

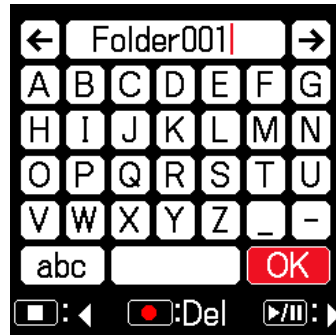



### NOTE

- The folder created will be set as the recording folder.
- The name of the folder created is written to the <PROJECT> or <SCENE> metadata of the recorded take.
- Spaces and @ marks cannot be input at name beginnings.

## ■ Selecting the take recording/playback folder

Use this procedure to select the folder that contains the take to be played back or the folder to use for recording takes and return to the Home Screen.

5. Press and hold  to open the Option screen.

6. Use  and  to select Select, and press .

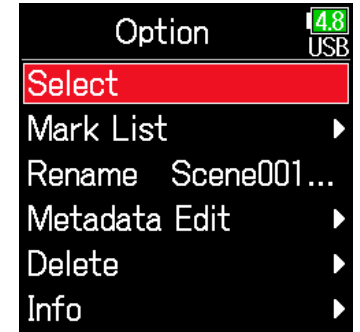

### NOTE

- Select a folder or take before pressing and holding  to open the Option screen.
- The first take inside the selected SD card or folder will be set as the playback take.

## ■ Checking take marks and using them for playback

A list of the marks in a recorded take can be shown.

5. Press and hold to open the Option screen.

6. Use and to select Mark List, and press .

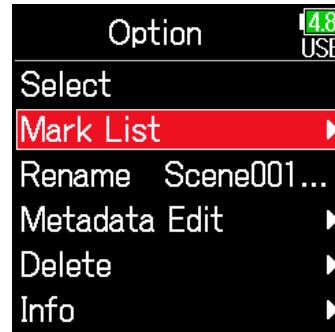

7. Use and to select a mark, and press .

The Home Screen will reopen, and playback will start from the mark.

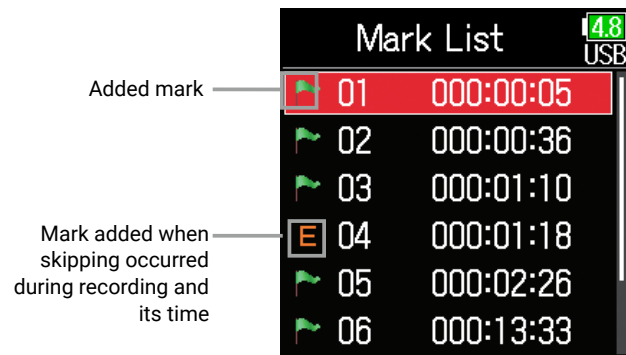

## ■ Changing folder and take names

5. Press and hold to open the Option screen.

6. Use and to select Rename, and press .

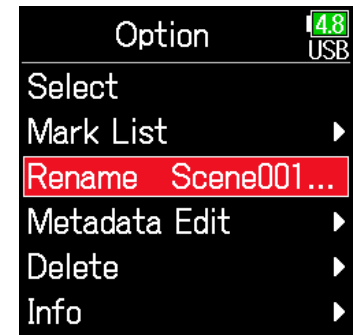

7. Edit the folder/take name.

See "Character input screen" (→ P. 11) for how to input characters.





### NOTE

- The edited name of the folder/take is written to the <PROJECT> or <SCENE> metadata.
- Spaces and @ marks cannot be input at name beginnings.

## ■ Deleting folders and takes

5. Press and hold  to open the Option screen.

6. Use  and  to select Delete, and press .

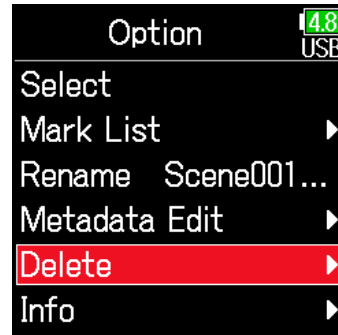



7. Use  and  to select the folder/take to delete, and press .

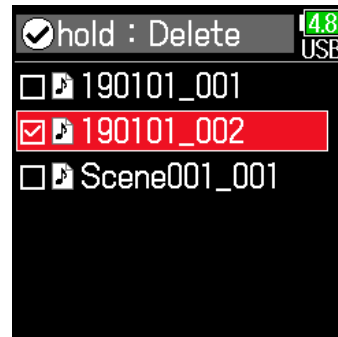

Press  to cancel deletion.



### NOTE

Press  to select/deselect all the folders and takes that are currently shown.

8. Press and hold .

9. Use  and  to select Execute, and press .

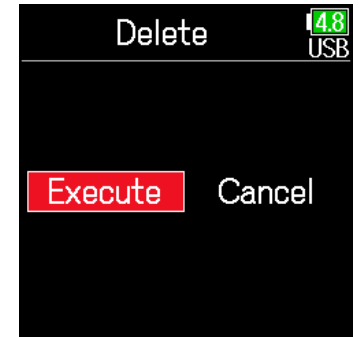



### NOTE

- Deleted folders and takes are not immediately erased from the SD card. They are moved to the TRASH folder.
- Deleting folders and takes in the TRASH folder will completely erase their data.

## ■ Checking folder and take information

4. Press and hold  to open the Option screen.

5. Use  and  to select Info, and press .

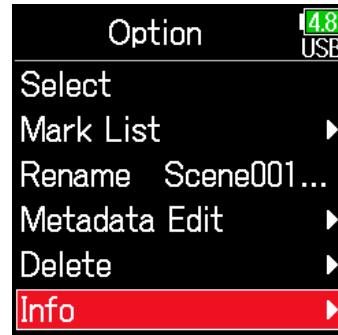

### ■ SD card selected

Free: Open space  
Size: Card capacity  
Remain: Remaining recording time

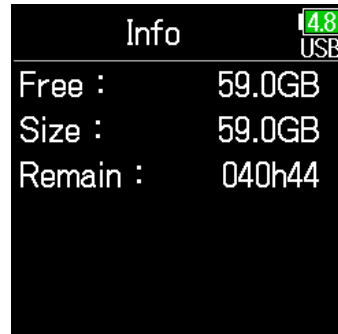

### ■ Folder selected

Date: Date  
Time: Time



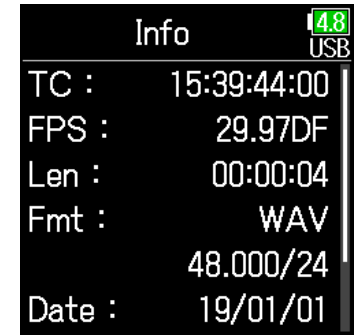

## ■ Take selected

TC: Timecode  
FPS: Timecode frame rate  
Len: Take recording length  
Fmt: Take sample format  
Date: Date  
Time: Time  
Size: Take size



## ■ Emptying the TRASH/FALSE TAKE folders

5. Use  and  to select TRASH or FALSE TAKE.





TRASH folder





FALSE TAKE folder

6. Press and hold .

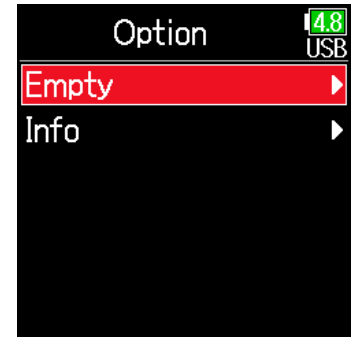
7. Use  and  to select Empty, and press .



8. Use  and  to select Execute, and press .

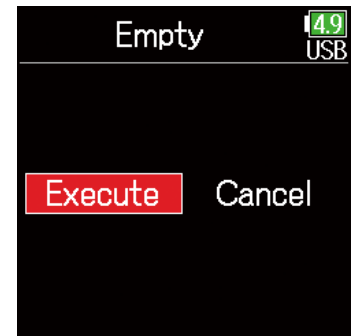

### NOTE

- Emptying the TRASH folder will completely erase the data in it.
- Emptying the FALSE TAKE folder does not immediately erase its data from the SD card. The data is moved to the TRASH folder.

## Overview of metadata (take information) stored in files

The **F6** writes a variety of information (metadata) to files during recording.

When these files are read by an application that supports metadata, the saved information can be checked and used.

### HINT

- Metadata is data that contains information related to other data. The **F6** saves scene names and take numbers, for example, as metadata in audio files.
- A chunk is a unit that contains multiple data in a single block.
- To use BEXT and iXML chunk metadata, an application that supports both data formats is necessary.

### ■ WAV file metadata

The metadata saved in files recorded by the **F6** in WAV format is collected in BEXT (Broadcast Audio Extension) and iXML chunks.

For details about the metadata saved in these chunks, see "Metadata contained in BEXT chunks in WAV files" ( → P. 185), "Metadata contained in iXML chunks in WAV files" ( → P. 186).

### ■ MP3 file metadata

The metadata saved in files recorded by the **F6** in MP3 format is written as ID3v1 tags.



For information about the ID3 fields and formats saved as metadata, see "Metadata and ID3 fields contained in MP3 files" ( → P. 188).

### HINT



- **F6** MP3 files conform to the MPEG-1 Layer III standard.
- MP3 metadata cannot be edited.

# Checking and editing take metadata

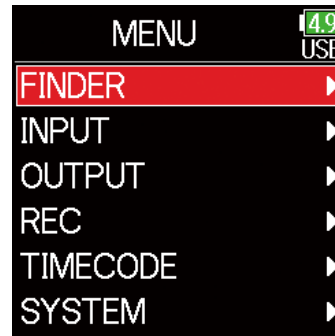

1. Press .

2. Use  and  to select FINDER, and press .



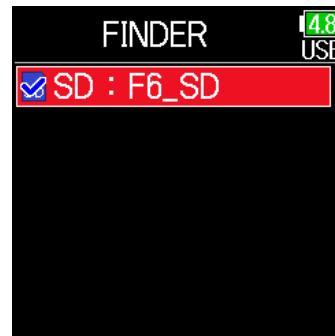

3. Use  and  to select an SD card, and press .







4. Use  and  to select a folder, and press .

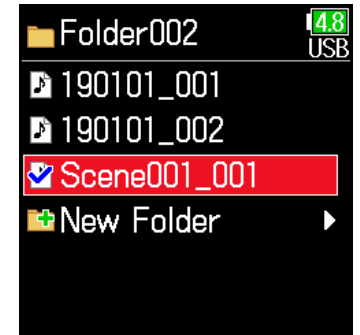

5. Use  and  to select a take, and press .

This opens the Option screen.  
See "Take and folder operations" for how to use the Finder (→ P. 57).



6. Use  and  to select Metadata Edit, and press .

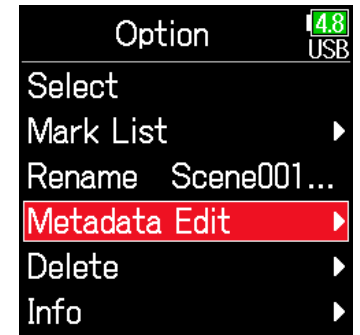



► Continue to one of the following procedures.

Checking and editing notes .....	P. 65
Selecting notes from the history list .....	P. 66
Checking and editing scene names .....	P. 66
Selecting a scene name from the history list .....	P. 67
Checking and editing take names .....	P. 68
Circling takes .....	P. 69
Changing tape names .....	P. 69
Changing project names .....	P. 70
Checking and editing track names .....	P. 70
Selecting a track name from the history list .....	P. 71

■ Checking and editing notes

7. Use and to select Note, and press .

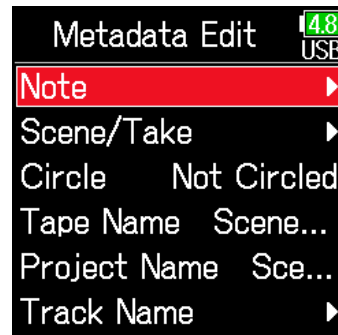

8. Use and to select Edit, and press .



9. Edit the note.

See "Character input screen" (→ P. 11) for how to input characters.



**NOTE**

The contents of this note is written to the <NOTE> metadata.

## ■ Selecting notes from the history list

7. Use and to select Note, and press .

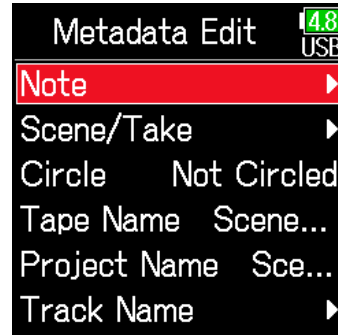

## ■ Checking and editing scene names

7. Use and to select Scene/Take, and press .

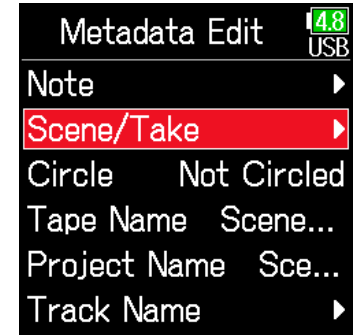

8. Use and to select History, and press .

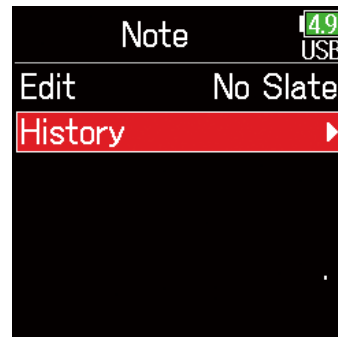

8. Use and to select Scene, and press .



9. Use and to select the desired history item, and press .



9. Use and to select Edit, and press .

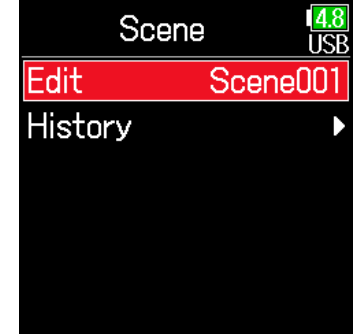

### NOTE

The history list will be erased if the Factory Reset function is used.

## 10. Edit the scene name.

See "Character input screen" (→ P. 11) for how to input characters.



### NOTE

The scene name is written to the <SCENE> metadata.

## ■ Selecting a scene name from the history list

7. Use ▲ and ▼ to select Scene/Take, and press ✓.

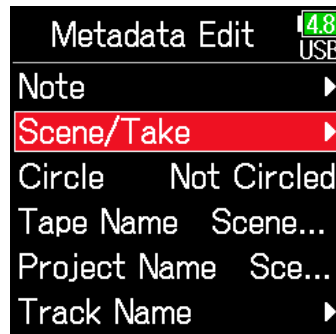

8. Use ▲ and ▼ to select Scene, and press ✓.

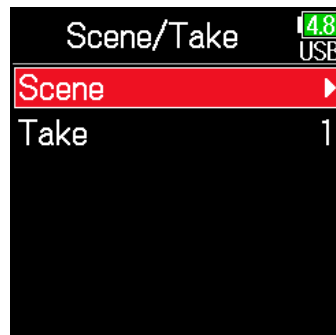

9. Use ▲ and ▼ to select History, and press ✓.

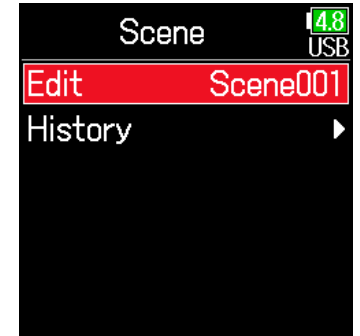



10. Use ▲ and ▼ to select the History item to use, and press ✓.







### NOTE

The history list will be erased if the Factory Reset function is used.

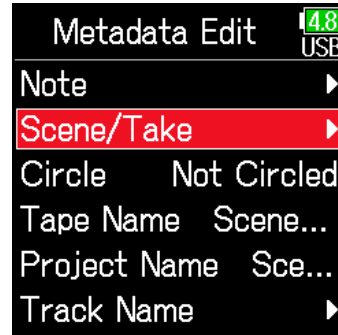
## ■ Checking and editing take numbers

7. Use  and  to select Scene/Take, and press .



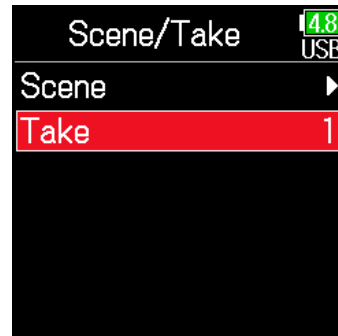

8. Use  and  to select Take, and press .

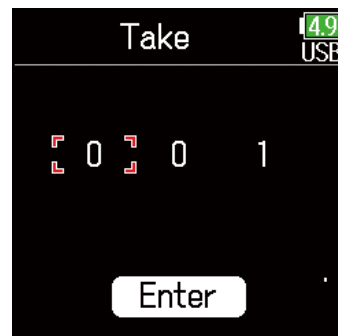

9. Change the take number.



## ■ Editing operations



- Move cursor or change value: Press  / 
- Select parameter to change: Press 

### HINT

This can be set from 1 to 999.

### NOTE

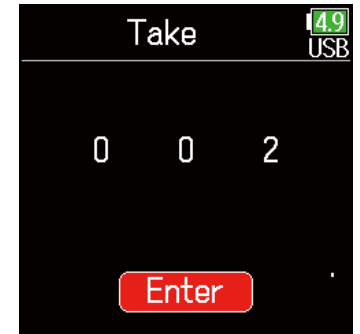

The take number is written to the <TAKE> metadata.

10. When done changing, use  and  to select Enter, and press .





## ■ Circling takes

An @ mark can be added to the beginning of the name of the best take to make it stand out. This is called a "circled take".

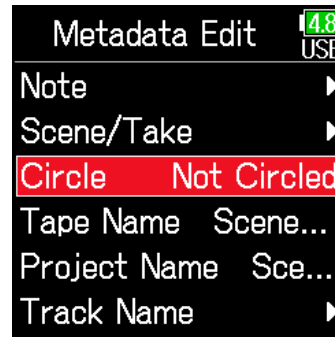
7. Use  and  to select Circle, and press .



8. Use  and  to select Circled, and press .

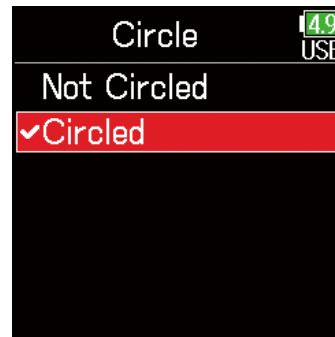

### NOTE

- To clear a circle, select Not Circed and press .
- This circled status is written to the <CIRCLE> metadata.

## ■ Changing tape names

7. Use  and  to select Tape Name, and press .



8. Edit the folder (tape) name.

See "Character input screen" (→ P. 11) for how to input characters.



### NOTE

- The folder (tape) name is written to the <TAPE> metadata.
- The folder (tape) name used immediately after recording is the name of the folder in which the take was recorded.

## ■ Changing project names

7. Use and to select Project Name, and press .

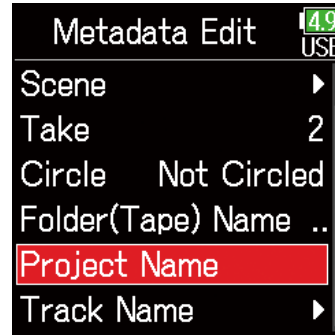

8. Edit the project name.

See "Character input screen" (→ P. 11) for how to input characters.

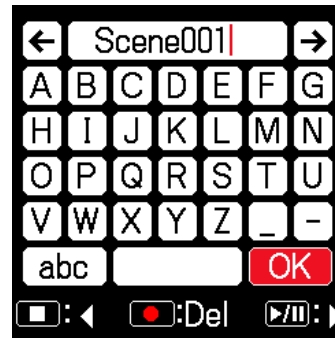

### NOTE

- The project name is written to the <PROJECT> metadata.
- The project name used immediately after recording is the name of the highest level folder (inside the SD card root directory) that contains the folder in which the take was recorded.

## ■ Checking and editing the track names

7. Use and to select Track Name, and press .

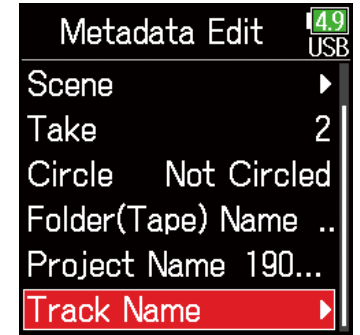

8. Use and to select a track, and press .



9. Use and to select Edit, and press .

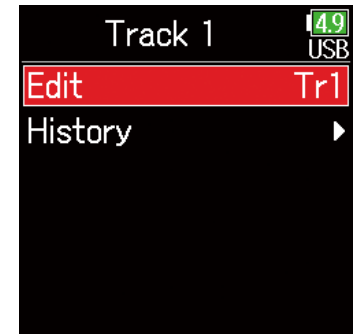

## 10. Edit the track name.

See "Character input screen" (→ P. 11) for how to input characters.



### NOTE

The track name is written to the <TRACK> <NAME> metadata.

## ■ Selecting a track name from the history list

7. Use and to select Track Name, and press .

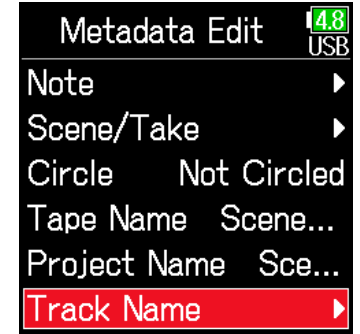

8. Use and to select a track, and press .

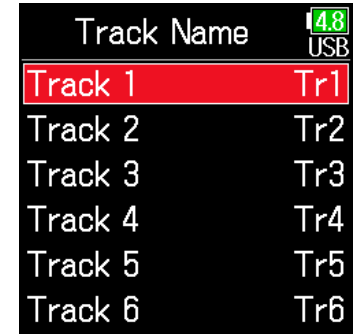

9. Use and to select History, and press .

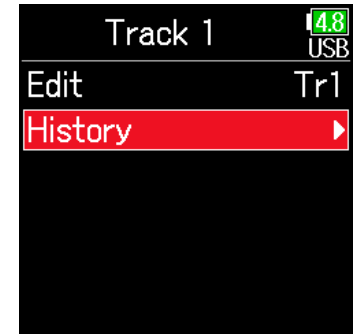

**10.** Use  and  to select the desired history, and press .

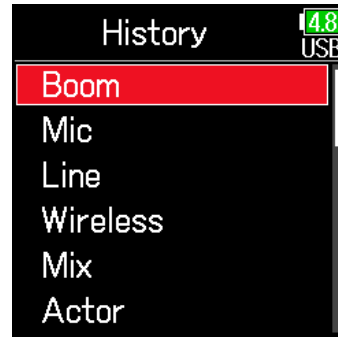

**NOTE**



The history list will be erased if the Factory Reset function is used.







# Writing a sound report

A sound report includes information about recording times and takes. Reports can be written as CSV format files (F6\_[folder name].CSV). Comments written in sound reports can also be edited.

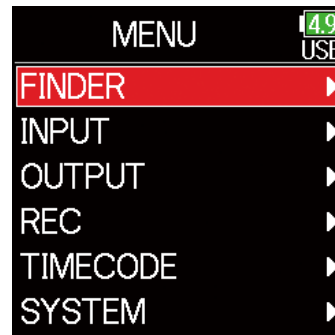
1. Press .

2. Use  and  to select FINDER, and press .



3. Use  and  to select the folder or SD card desired for sound report creation, and press and hold .

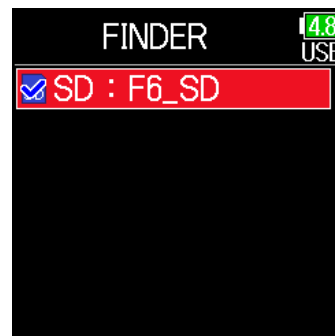

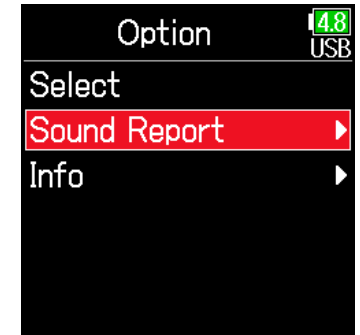

4. Use  and  to select Sound Report, and press .







▶ Continue to one of the following procedures.

Writing sound reports .....	P. 74
Editing comments .....	P. 74
Selecting comments from the history list.....	P. 75

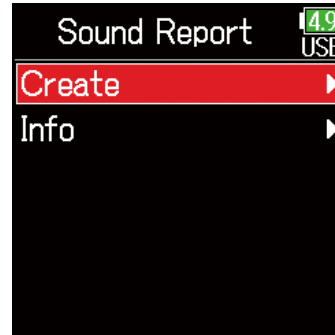
## ■ Writing sound reports

5. Use  and  to select Create, and press .



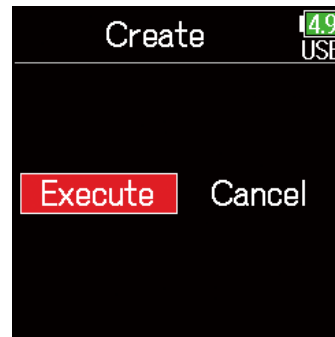

6. Use  and  to select Execute, and press .
- This writes the sound report inside the selected SD card or folder.







### NOTE

- Only information about takes in the folder or SD card is written in the sound report.
- Be careful because a sound report file with the same name will be overwritten.

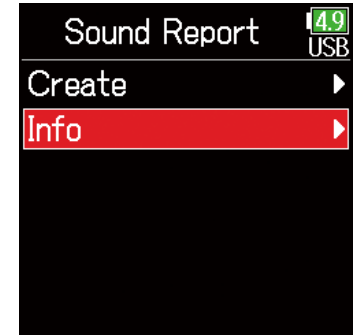
## ■ Editing comments

5. Use  and  to select Info, and press .



6. Use  and  to select Edit, and press .





7. Edit the comment.

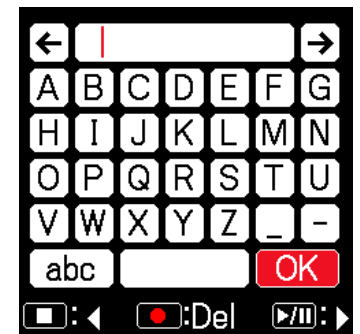

See "Character input screen" (→ P. 11) for how to input characters.



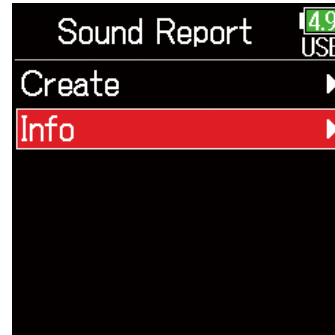

## ■ Selecting comments from the history list

5. Use  and  to select Info, and press .



6. Use  and  to select History, and press .



7. Use  and  to select the desired history item, and press .



### NOTE

The history list will be erased if the Factory Reset function is used.

# Input settings

## Adjusting the input signal monitoring balance

The volume of each track can be adjusted when monitoring input signals.

1. Open the Home Screen  
(→ P. 10).

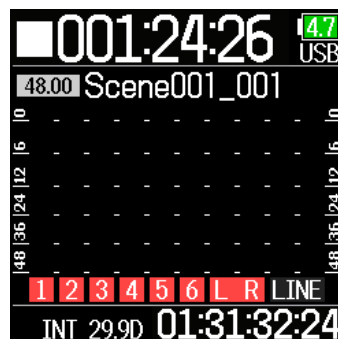

2. Use  to adjust the faders.

### HINT

The fader setting range is muted and  $-48.0$  to  $+24.0$  dB.

### NOTE

- Mix settings are saved separately for each recorded take and can be changed during playback (→ P. 52).
- Mix settings are not saved with the take when the recorded file format is MP3.

# Monitoring the input signals of specified tracks

The input signals of specified tracks can be monitored.

Even tracks that have not been set to record can be input to the PFL screen and their input sounds monitored.

This is convenient when using tracks as return inputs.

Various settings can be made for selected tracks.

## 1. Press when the Home Screen is open.

The PFL screen for the track that was last opened opens, and the status indicator lights orange.

Only the input sound of the track show can be monitored through headphones.

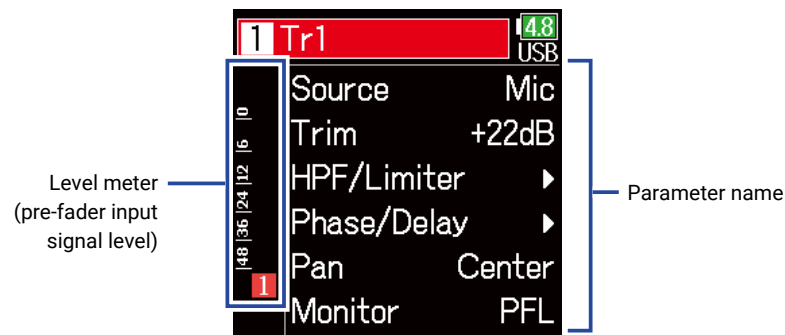



Parameter	Explanation
Source	This sets the input source.
Trim	This sets the input level.
HPF/Limiter	This sets the high pass filter and limiter.
Phase/Delay	This sets the phase reversal and delay.
Pan	This sets the panning.
Monitor	This sets the monitoring volume on the PFL screen.

### NOTE

This does not change the signals output from line outputs.

### HINT

- Use  and  to select parameters and change setting values.
- When the cursor is on the topmost track number, press  to show the next track.



## 2. Press .

This opens the Home Screen.

# Setting the input source

The input source and phantom power on/off status can be set for each track.

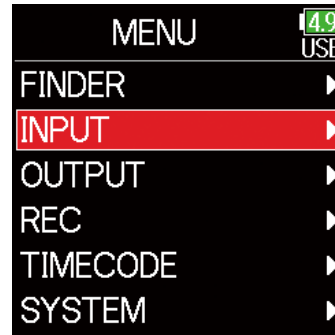

1. Press .

2. Use  and  to select INPUT, and press .



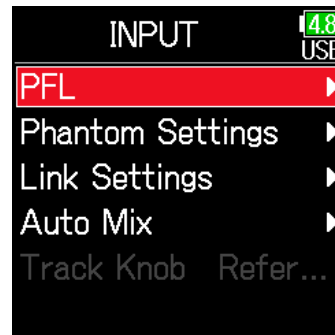

3. Use  and  to select PFL, and press .



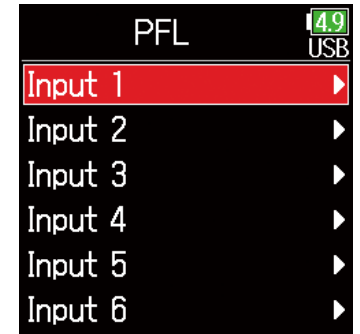

4. Use  and  to select a track, and press .

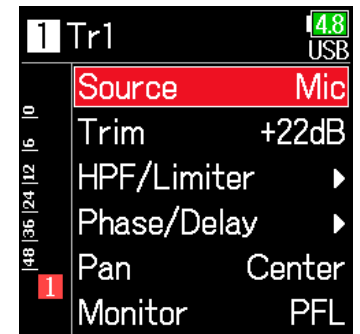

5. Use  and  to select Source, and press .



6. Use  and  to select the input source, and press .

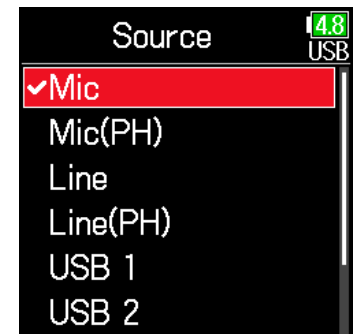

Setting	Explanation
Mic	Use when connecting a mic or other equipment with a low input level.
Mic (PH)	Use for mic level with phantom power.
Line	Use when connecting line level equipment. The input level will be reduced 20 dB compared to when Mic is selected.
Line (PH)	Use this setting for line level with phantom power.
USB 1–4	When AIF with Rec ( → P. 140) is set to On, computer output signals are treated as input signals



**HINT**

For phantom power voltage, see “Changing the phantom power settings” ( → P. 92).

# Setting the monitoring volume on the PFL screen

On the PFL screen, the monitoring sound can be set to be either pre-fader listening (PFL) or fader solo (SOLO).

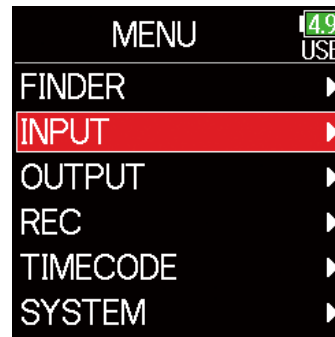

1. Press .

2. Use  and  to select INPUT, and press .



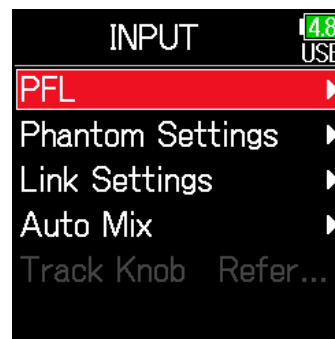

3. Use  and  to select PFL, and press .



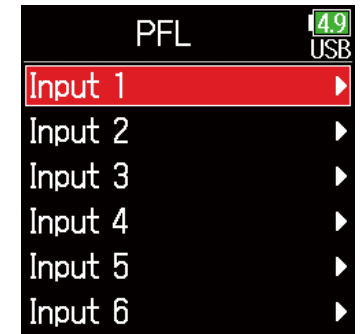

4. Use  and  to select a track, and press .

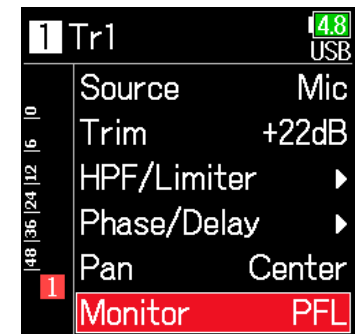

5. Use  and  to select Monitor, and press .



6. Use  and  to select the mode, and press .

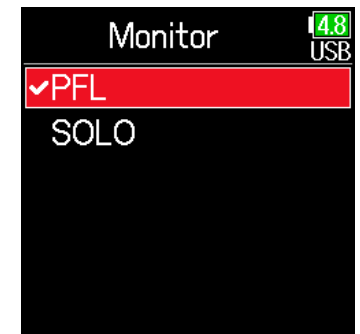



Setting	Explanation
PFL	On the PFL screen, monitor the pre-fader sound.
SOLO	On the PFL screen, monitor the post-fader sound.



#### NOTE

- When the PFL screen is open during playback, the monitoring sound will be post-fader (SOLO) regardless of the setting.
- The pre-fader and post-fader monitoring positions depend on the set recording mode. See the block diagrams for details about the positions (→ "Block diagrams" on P. 190).

# Cutting low-frequency noise

The high pass filter can cut low frequencies to reduce the sound of wind, vocal pops and other noise.

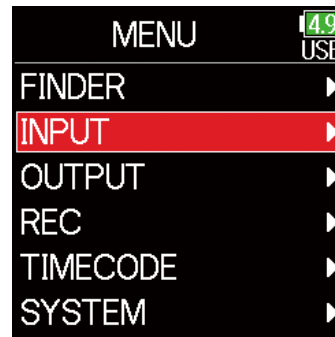

1. Press .

2. Use  and  to select INPUT, and press .

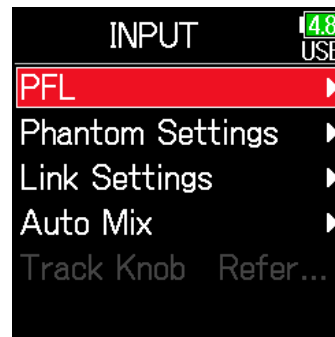

3. Use  and  to select PFL, and press .



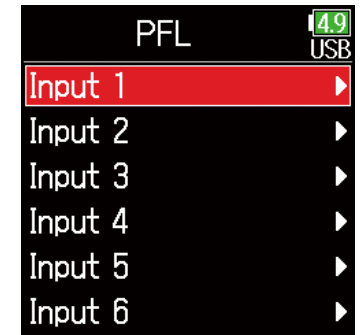

4. Use  and  to select a track, and press .



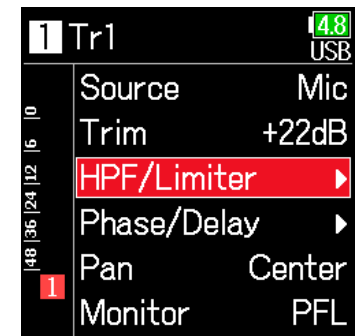

5. Use  and  to select HPF/Limiter, and press .

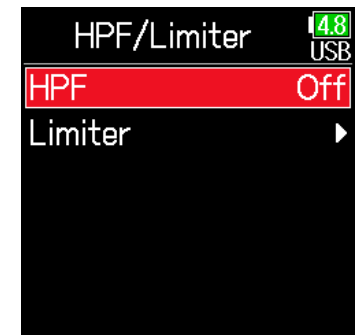

6. Use  and  to select HPF, and press .



7. Use  and  to select the desired cutoff frequency, and press .

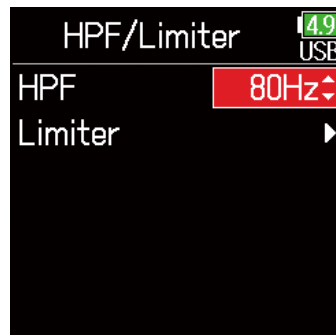

**HINT**

This can be set to Off or between 10 and 240 Hz.

# Input limiter

The limiter can prevent distortion by reducing input signals that have excessively high levels.

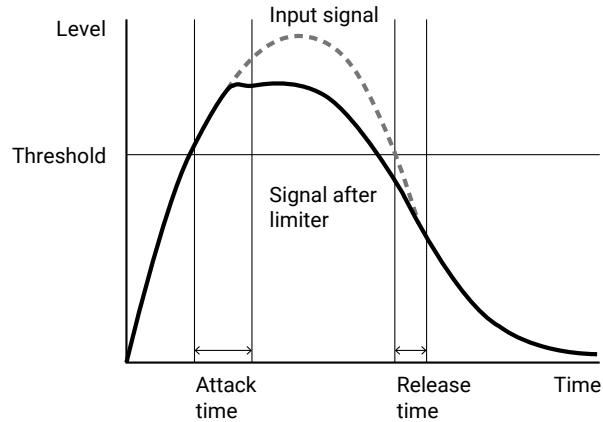



When the limiter is ON, if the input signal level exceeds the set threshold value, the input signal level will be suppressed to prevent the sound from distorting.

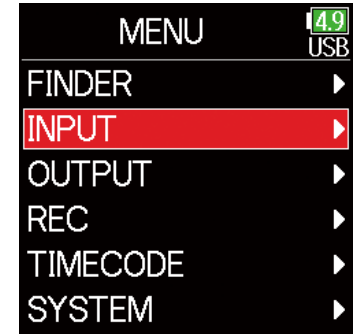

The amount of time after the input signal exceeds the threshold until compression of the output signal is maximized is called the “attack time”. The amount of time after the input signal goes below the threshold until the limiter stops compressing the signal is called the “release time”. Change these two to adjust the audio quality.

1. Press .
2. Use  and  to select INPUT, and press .

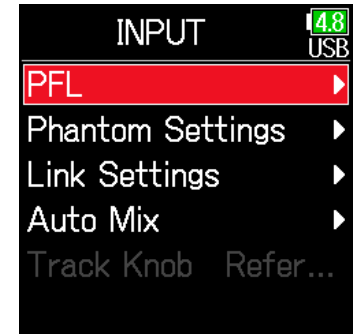

3. Use  and  to select PFL, and press .



4. Use  and  to select a track, and press .

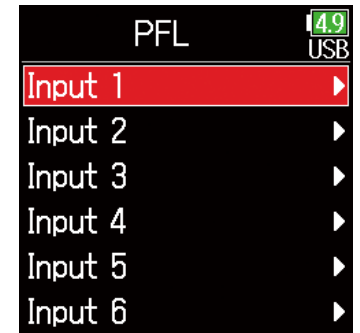

5. Use and to select HPF/Limiter, and press .

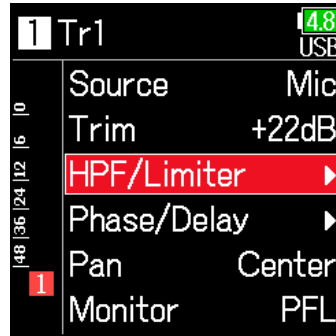

6. Use and to select Limiter, and press .



► Continue to one of the following procedures.

Using the limiter .....	P. 85
Setting the type .....	P. 87
Setting the threshold .....	P. 87
Setting the attack time .....	P. 88
Setting the release time .....	P. 88
Setting the target level .....	P. 89

### Using the limiter

7. Use and to select On/Off, and press .

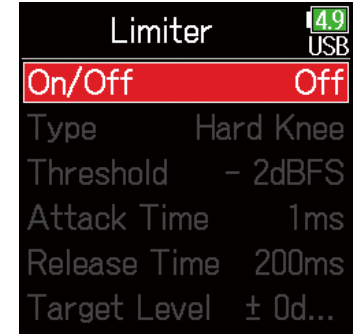

8. Use and to select the setting, and press .

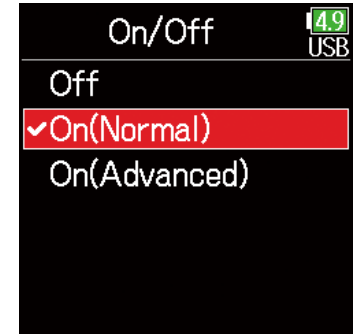

### On (Normal)

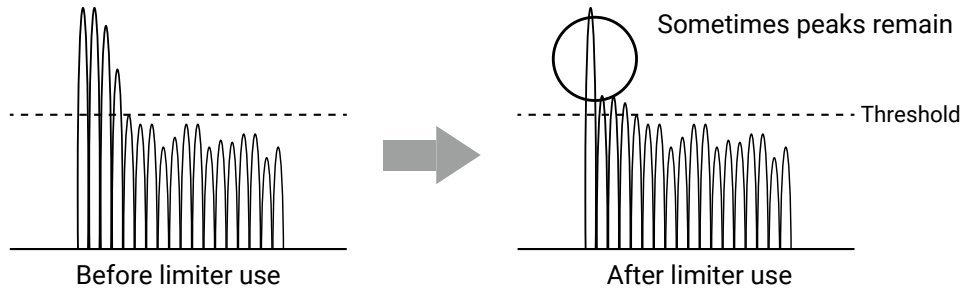

### On (Advanced)

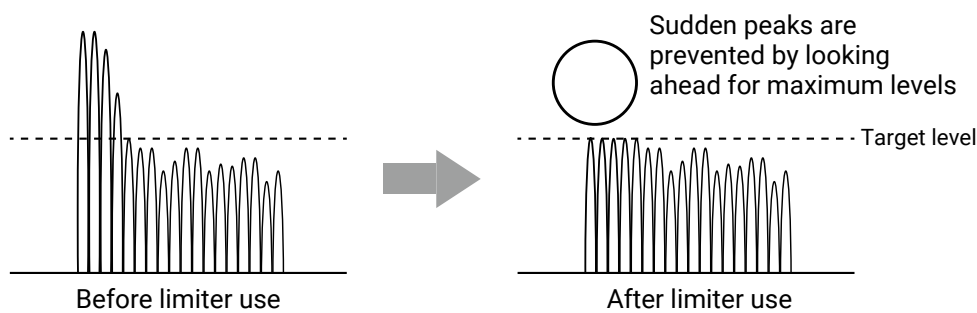

#### NOTE

When set to On (Advanced), the input latency of the **F6** increases 1 ms. When monitoring sounds being recorded with a mic in real-time, increased latency can cause interference between the sound being recorded that is transmitted through the air and the delayed monitored sound, possibly making accurate monitoring difficult.

#### NOTE



- When set to On (Advanced), the Sample Rate cannot be set to 192 kHz.
- Moreover, when the Sample Rate is set to 192 kHz, the On (Advanced) setting cannot be selected.

Setting	Explanation
Off	This disables the limiter.
On (Normal)	This applies an ordinary limiter. The ratio is 20:1.
On (Advanced)	By detecting the maximum level in advance, this optimized limiter prevents distortion even more than ordinary limiter operation. The ratio is $\infty$ :1, providing increased internal headroom.

## ■ Setting the type

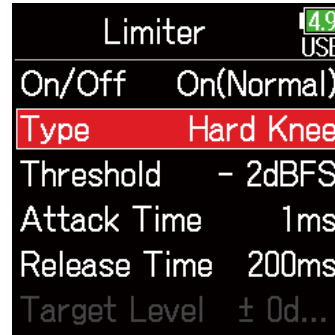
7. Use  and  to select Type, and press .



8. Use  and  to select the type, and press .

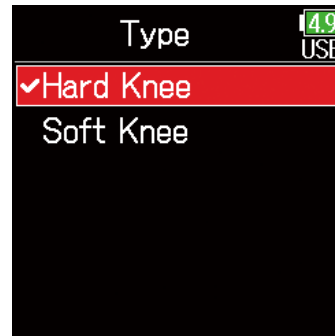



Setting	Explanation
Hard Knee	Only peaks that exceed the threshold are attenuated. There is no effect below the threshold.
Soft Knee	The limiter gradually affects the signal about 6 dB below the threshold for a gentler effect.

### NOTE



This setting becomes available when **On/Off** is set to **On (Normal)**.

## ■ Setting the threshold

This sets the base level from which the limiter operates.

7. Use  and  to select Threshold, and press .



8. Use  and  to adjust the setting, and press .

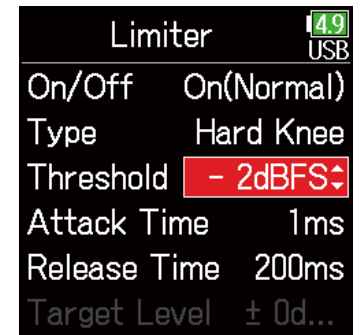

### HINT



This can be set from -16 to -2 dBFS.

### NOTE



This setting becomes available when **On/Off** is set to **On (Normal)**.

## ■ Setting the attack time

This sets the amount of time until compression starts after the input signal exceeds the threshold.

7. Use  and  to select Attack Time, and press .

Limiter 	
On/Off	On(Normal)
Type	Hard Knee
Threshold	- 2dBFS
Attack Time	1ms
Release Time	200ms
Target Level	± 0d...

8. Use  and  to adjust the time, and press .

Limiter 	
On/Off	On(Normal)
Type	Hard Knee
Threshold	- 2dBFS
Attack Time	1ms 
Release Time	200ms
Target Level	± 0d...

### HINT



This can be set from 1 to 4 ms.

### NOTE



This setting becomes available when On/Off is set to On (Normal).



## ■ Setting the release time

This sets the amount of time until compression stops after the input signal goes below the threshold.

7. Use  and  to select Release Time, and press .

Limiter 	
On/Off	On(Normal)
Type	Hard Knee
Threshold	- 2dBFS
Attack Time	1ms
Release Time	200ms
Target Level	± 0d...

8. Use  and  to adjust the time, and press .

Limiter 	
On/Off	On(Normal)
Type	Hard Knee
Threshold	- 2dBFS
Attack Time	1ms
Release Time	200ms 
Target Level	± 0d...

### HINT

Limiter operation is linked for tracks that have stereo link or MS stereo link enabled. If the signal for either linked channel reaches the threshold, the limiter will operate on both tracks.



### NOTE

This setting becomes available when On/Off is set to On (Normal).





## ■ Setting the target level

When the limiter **On/Off** setting is set to **On (Advanced)**, use this to set the target output level for the signal.

7. Use  and  to select Target Level, and press .



8. Use  and  to adjust the setting, and press .



### HINT

- This can be set from -16 to 0 dBFS.
- After a signal passes through the limiter, it will not exceed the set target level value.



### NOTE

This setting becomes available when On/Off is set to On (Advanced).

# Inverting the input phase

The phase of the input signal can be inverted. This is useful when sounds cancel each other out due to mic settings.

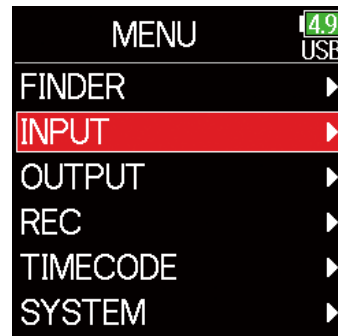

1. Press .

2. Use  and  to select INPUT, and press .



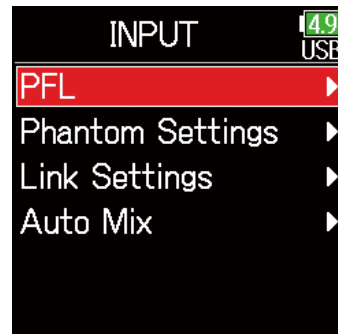

3. Use  and  to select PFL, and press .



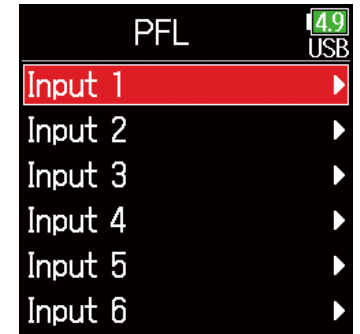

4. Use  and  to select a track, and press .



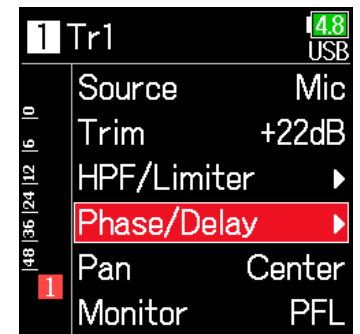

5. Use  and  to select Phase/Delay, and press .

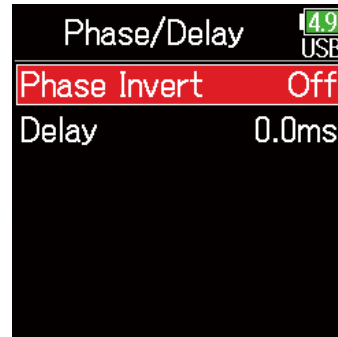

6. Use  and  to select Phase Invert, and press .



7. Use  and  to select On, and press .

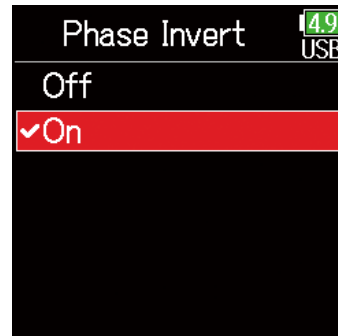

# Changing the phantom power settings

The **F6** can provide phantom power. The voltage can be set to +24V or +48 V and it can be turned on/off for each input separately.



## HINT

Phantom power is a function that supplies power to devices that require an external power supply, including some condenser mics. The standard power is +48 V, but some devices can operate with lower voltages.



## NOTE

Do not use this function with devices that are not compatible with phantom power. Doing so could damage the device.

1. Press .

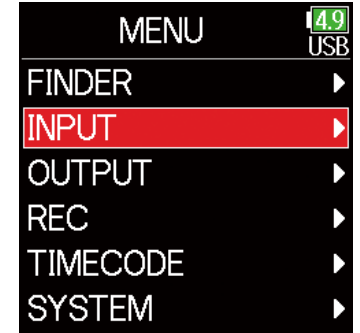
2. Use  and  to select INPUT, and press .



3. Use  and  to select Phantom Settings, and press .

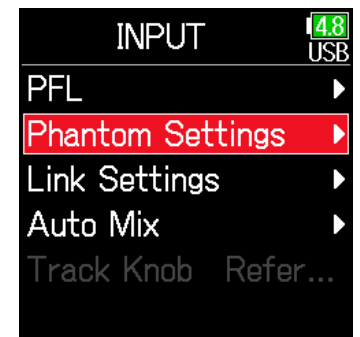

▶ Continue to one of the following procedures.

Setting the voltage .....	P. 93
Disabling phantom power during playback .....	P. 93
Using phantom power .....	P. 78

## ■ Setting the voltage

4. Use and to select Voltage, and press .

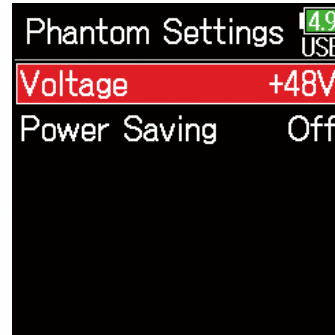

5. Use and to select the voltage, and press .

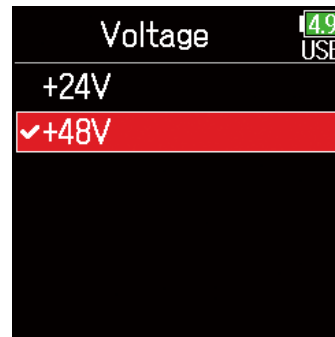

### HINT

When using mics and other equipment that can operate with voltages less than +48 V, selecting the lower voltage can reduce the **F6** power consumption.

## ■ Disabling phantom power during playback

4. Use and to select Power Saving, and press .

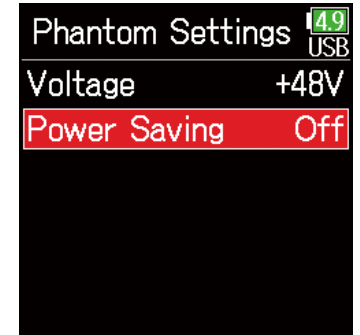

5. Use and to select On (PH off during playback), and press .

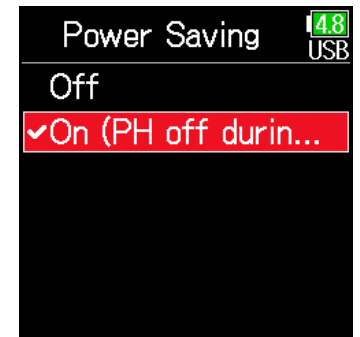

Setting	Explanation
Off	Phantom power is supplied even during playback.
On (PH off during playback)	Phantom power is not supplied during playback. This can reduce the <b>F6</b> power consumption.

### HINT

If mics do not need phantom power during playback, disabling it can reduce **F6** power consumption.



### NOTE

This setting affects all tracks.



# Applying delay to input signals

If there are differences in the timing of input sounds, use this function to correct them when recording.

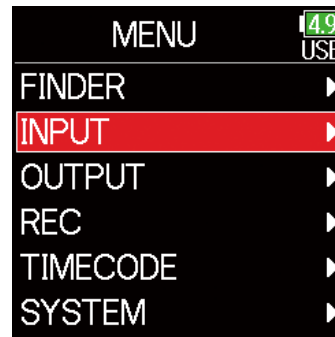

1. Press .

2. Use  and  to select INPUT, and press .



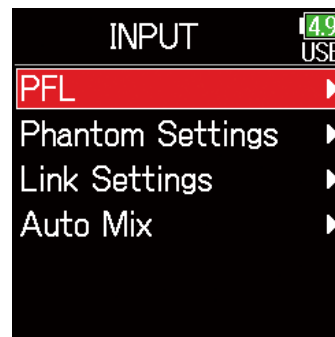

3. Use  and  to select PFL, and press .



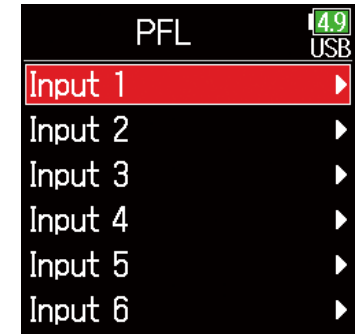

4. Use  and  to select a track, and press .



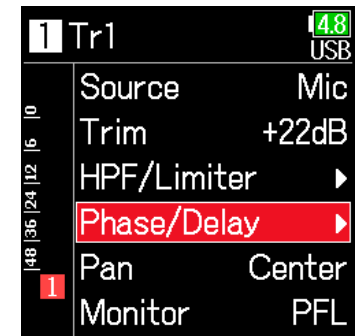

5. Use  and  to select Phase/Delay, and press .

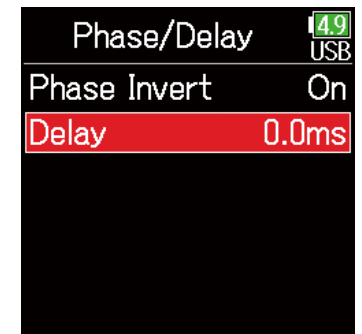

6. Use  and  to select Delay, and press .



7. Use  and  to adjust the delay time, and press .

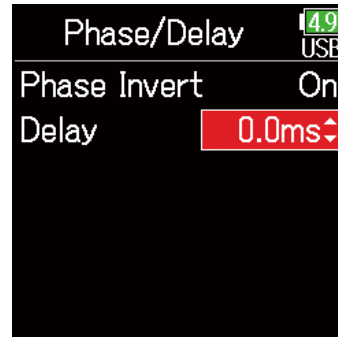

**HINT**

This can be set from 0 to 30.0 ms.

**NOTE**

When Sample Rate is set to 192 kHz, Delay is disabled.

# Linking inputs as a stereo pair

By enabling the stereo link for tracks 1/2, 3/4 or 5/6, the corresponding Inputs (1/2, 3/4 or 5/6) can be handled as a stereo pair. When linked, Input 1, 3 or 5 will be the left channel and Input 2, 4 or 6 will be the right channel.

## ■ MS stereo format overview

This method takes input from a directional mid mic, which captures sound in the center, and a bidirectional side mic, which captures sounds from the left and right, and converts it to stereo.

The stereo width can be changed as desired by adjusting the side mic level.

Since this method can capture a wide stereo image, it is ideal for recording large open spaces with numerous sound sources, including orchestras, live concerts and soundscapes.

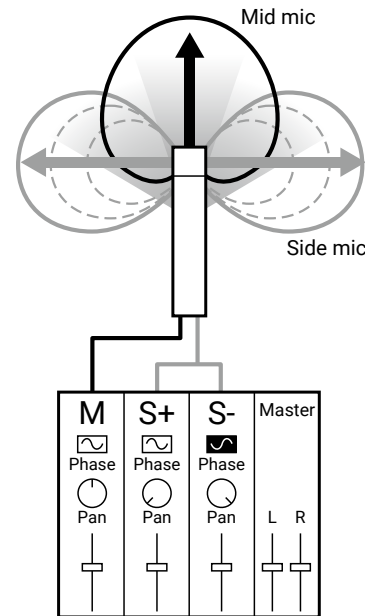

This technique is also extremely effective when you want to adjust room ambience.

Since it offers a high degree of freedom, it is used not only in studios but also for a wide range of recording, even for rehearsals and live performances.

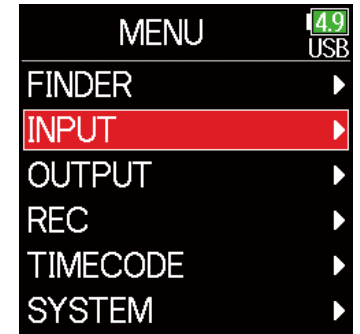

1. Press .
2. Use  and  to select INPUT, and press .



3. Use  and  to select Link Settings, and press .

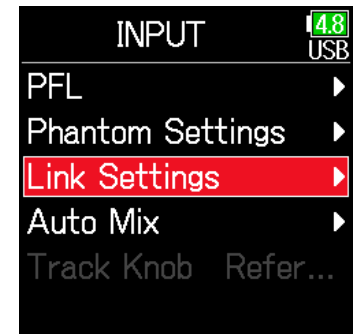



4. Use and to select Input Link, and press .

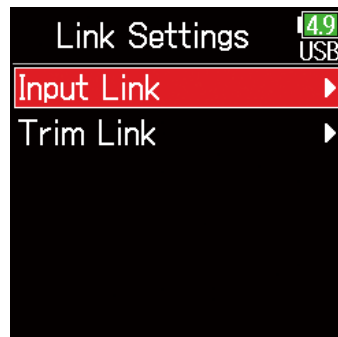

Setting	Explanation
Stereo	When stereo-linked, inputs are handled normally.
MS	When stereo-linked, signals from mid-side mics are converted to ordinary stereo.

## ■ Setting stereo links

### Stereo

Use and to select Stereo, and press .

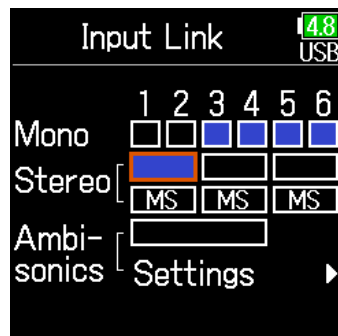

### NOTE

- When stereo-linked, odd tracks are handled as left and even tracks as right channels.
- When MS stereo-linked, odd tracks are handled as mid signals and even tracks as side signals.

### HINT

When MS stereo-linked, the method to balance mid and side is according to the recording mode as follows.

- Float (32bit): Use for each track to adjust the mid/side balance.
- Not Float (32bit): Use the input level for each track to adjust the mid/side balance. (See "Adjusting input levels → P. 25.)

### MS

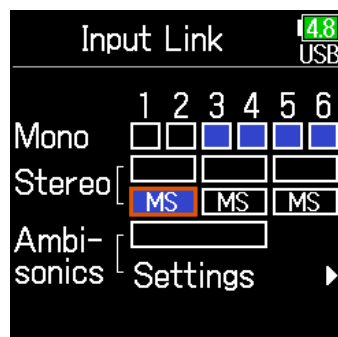

Use and to select MS, and press .







# Adjusting multiple track input levels together

The input levels of multiple tracks can be linked and adjusted at the same time.

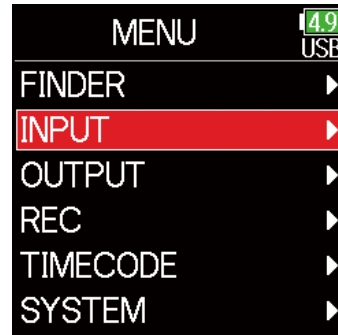

1. Press .

2. Use  and  to select INPUT, and press .

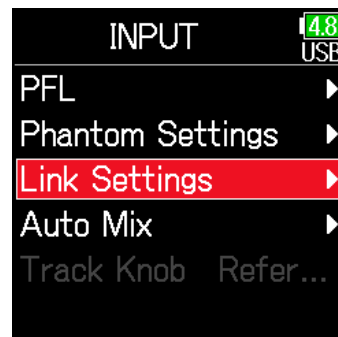

3. Use  and  to select Link Settings, and press .



4. Use  and  to select Trim Link, and press .

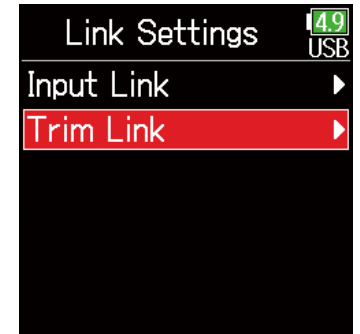

5. Use  and  to select a track to link, and press .

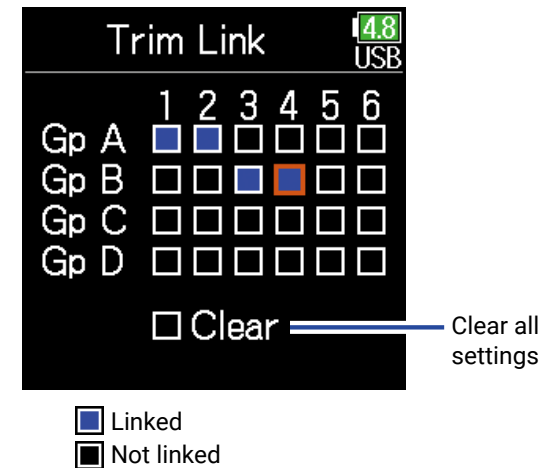

## NOTE



- A track cannot be in more than one group at a time.
- The input levels of tracks set to MS stereo link will also be linked if those tracks are put into groups.

# Changing the automatic mixing setting



When using multiple mics to capture audio during a meeting, for example, automatically attenuating the inputs of mics that are not in active use provides the following benefits.

- The likelihood of feedback is reduced.
- Background noise, including fans and crowds, is suppressed to a certain level regardless of the number of people.
- Sound quality degradation due to phase differences caused by variations in the distances of multiple mics is reduced.

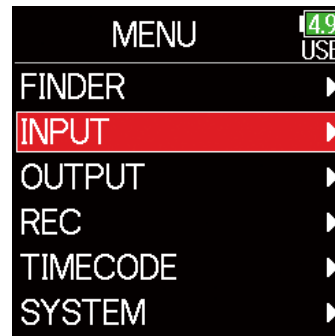

1. Press .

2. Use  and  to select INPUT, and press .

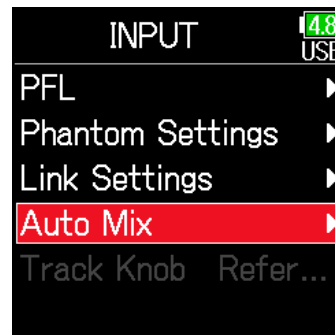

3. Use  and  to select Auto Mix, and press .



4. Use  and  to select a track, and press .

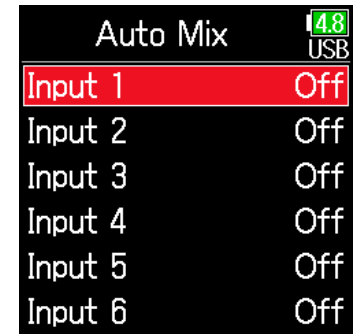

5. Use  and  to select On, and press .

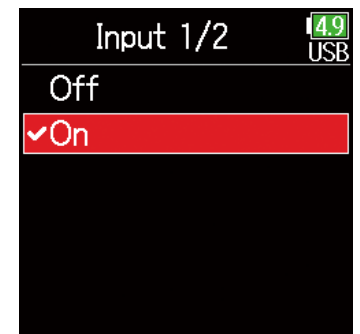



**NOTE**

- The following functions and settings cannot be used with this function.
  - The sampling rate cannot be set to 192 kHz.
  - The Ambisonic format cannot be set to any value other than Off.
- When monitoring sounds being recorded with a mic in real-time, increased latency can cause interference between the sound being recorded that is transmitted through the air and the delayed monitored sound, possibly making accurate monitoring difficult.



# Setting the Ambisonic format

By connecting mics that can output Ambisonic A-format signals to Inputs 1–4, audio can be converted to Ambisonic B-format and recorded.

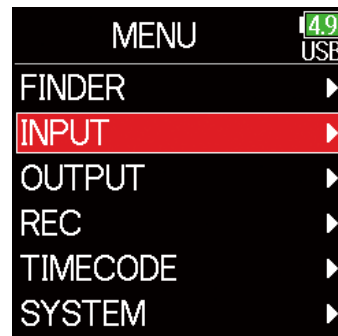

1. Press .

2. Use  and  to select INPUT, and press .



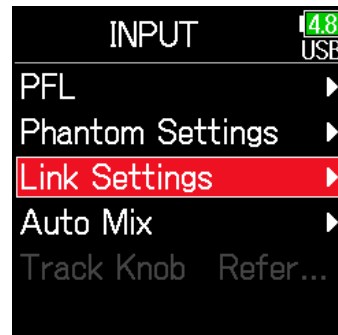

3. Use  and  to select Link Settings, and press .

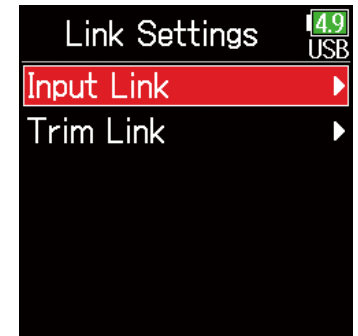

4. Use  and  to select Input Link, and press .



5. Use  and  to move the cursor to Ambisonics, and press .

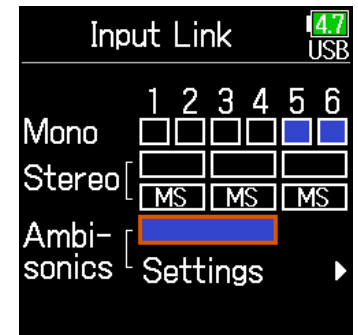

6. Use and to select Settings, and press .

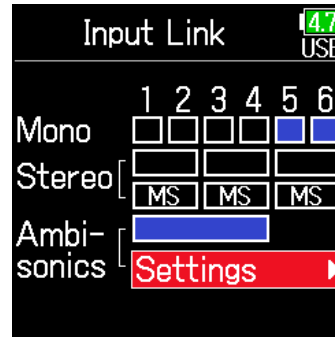

7. Use and to select Format, and press .

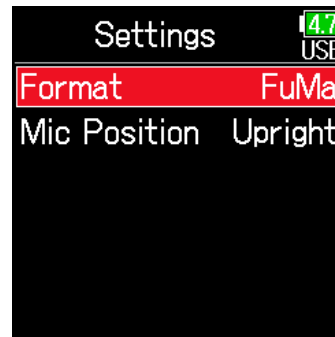

8. Use and to select the format, and press .

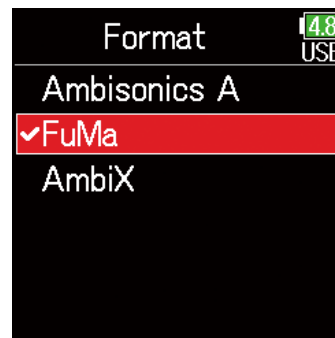

## FuMa

This converts the signals from Inputs 1–4 to the Ambisonic FuMa B-format, and saves them as a 4-channel polyphonic file.

## AmbiX

This converts the signals from Inputs 1–4 to the Ambisonic AmbiX B-format, and saves them as a 4-channel polyphonic file.

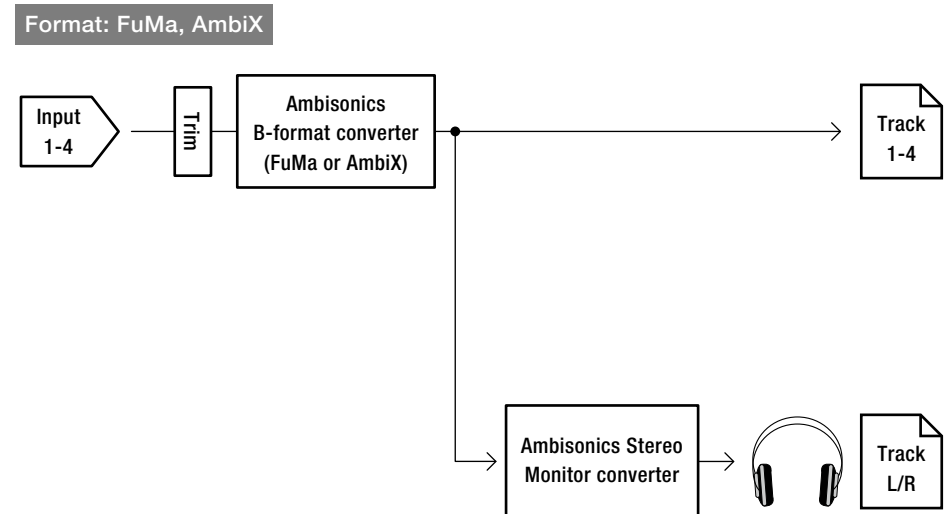

## Ambisonics A

This saves the signals from Inputs 1–4 as a 4-channel polyphonic file without converting them to an Ambisonic B-format. The monitoring signal is converted to Ambisonic B-format and then to an ordinary stereo signal.

Format: Ambisonics A

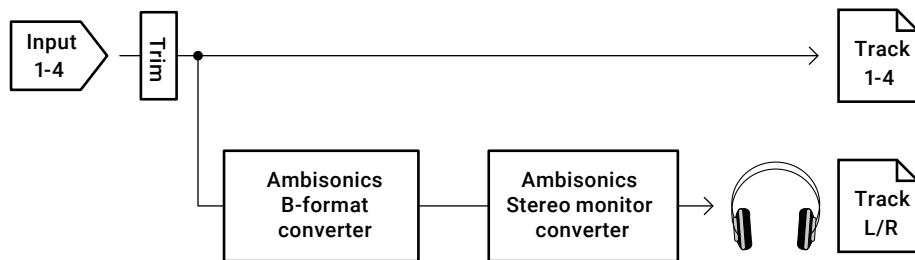

### NOTE

- The sampling rate can only be set to 192 kHz when **Ambisonic Mode** is **Off**.
- Ambisonic files are saved as 4-channel polyphonic files, not as mono or stereo files.
- The following parameters cannot be set for tracks using Ambisonic Mode input.
  - Phase Invert
  - Delay
  - Pan
  - Input Link
  - Trim Link
- Files recorded when Ambisonic format is not off will play back as Ambisonic audio sources rather than ordinary 4-channel polyphonic files. For this reason, these tracks cannot be panned or muted during playback
- This cannot be used with the Auto Mix function.



### HINT

- Ambisonic can also be set during use as an audio interface (Multi Track).
- Even when **Ambisonic** format is not **Off**, PFL buttons can be selected to monitor their track input sounds. When **Monitor** is set to **PFL**, sounds can be monitored before they are converted to Ambisonic B-format. When PFL mode is set to **SOLO**, sounds can be monitored after they are converted to Ambisonic B-format.
- The following parameters that can be set on the PFL screen are linked for Ambisonic input tracks.
  - Source
  - Trim
  - HPF
  - Limiter
  - Phantom
  - Fader
  - PFL Monitor



# Setting the mic position used for Ambisonic recording

By setting the mic orientation used during Ambisonic recording as an **F6** parameter, proper positioning can be maintained when converting to Ambisonic B format if the mic orientation is changed from upright, upside down or horizontal.

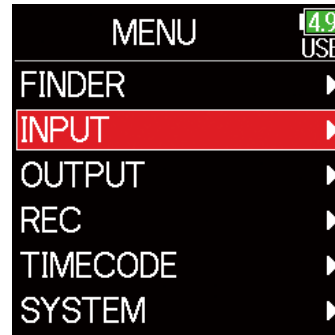

1. Press .

2. Use  and  to select INPUT, and press .



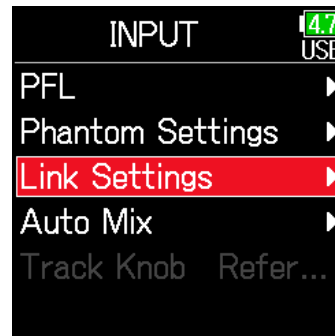

3. Use  and  to select Link Settings, and press .

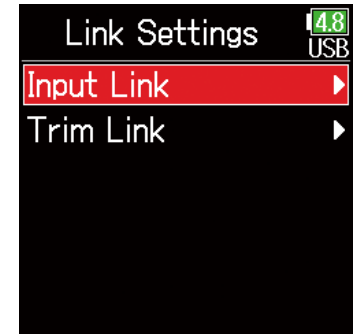

4. Use  and  to select Input Link, and press .



5. Use  and  to select Ambisonics Settings, and press .

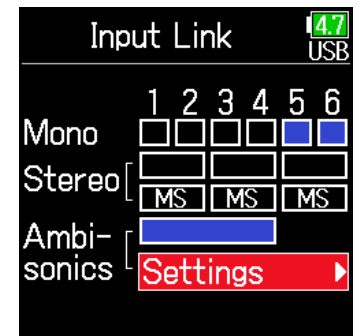



6. Use ▲ and ▼ to select Mic Position, and press ✓.

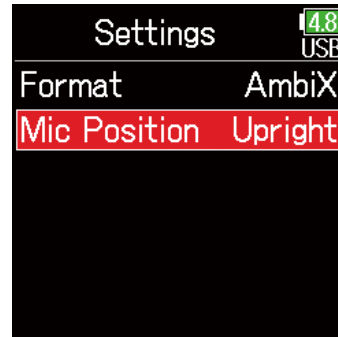

7. Use ▲ and ▼ to select the mic orientation, and press ✓.

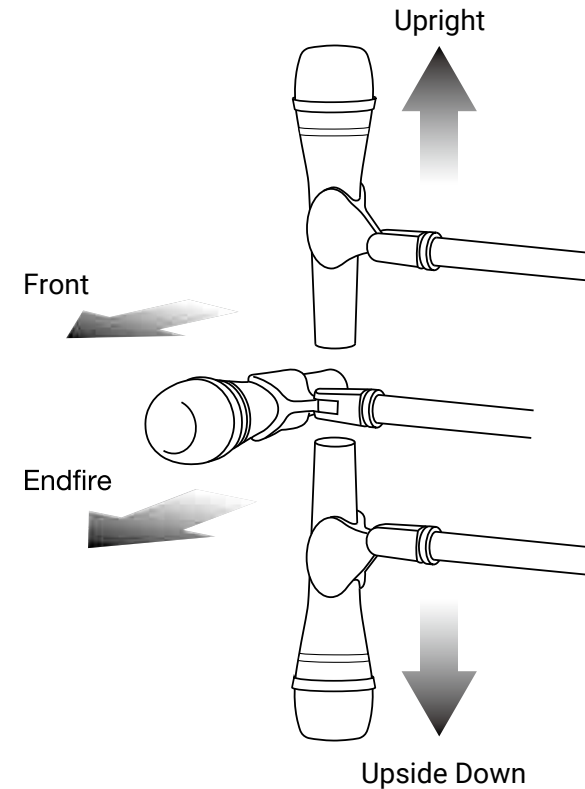

Setting	Explanation
Upright	Use this setting to record with the mic upright.
Upside Down	Use this setting to record with the mic upside down.
Endfire	Use this setting to record with the mic oriented horizontally.

**HINT**

- Using the mic upright is recommended for Ambisonic recording in order to minimize reflections from the floor and the mic itself.
- When it is difficult to use the mic in an upright orientation, you can place it upside down or pointing forward and change the Mic Position setting accordingly.

**NOTE**

If this setting and the mic position do not match, sound positioning will not be properly re-created during conversion to Ambisonic B format.

# Output settings



## Setting signals sent to the headphone output

Signals sent to the headphone output can be set to either prefader or postfader for each track. Saving 10 setting combinations (Setting 1–Setting 10) it is possible.

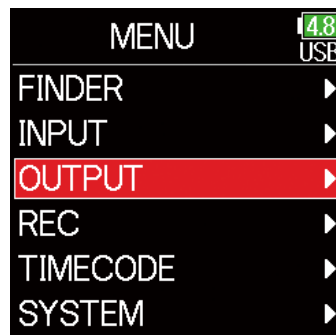

1. Press .

2. Use  and  to select OUTPUT, and press .

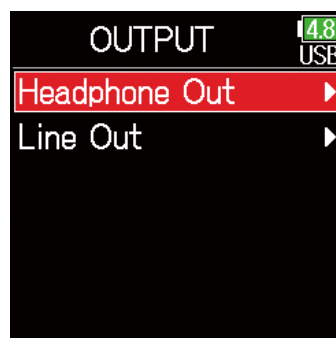

3. Use  and  to select Headphone Out, and press .



4. Use  and  to select Routing, and press .

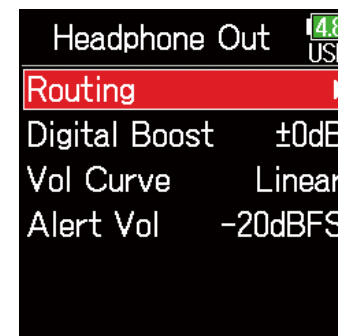

5. Use  to select the desired setting.

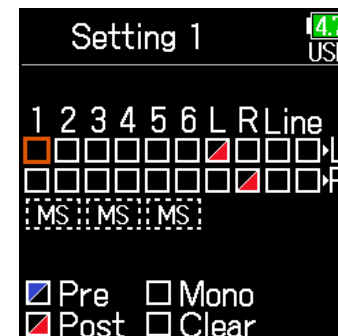

### NOTE

Use  on any screen to cycle through Settings 1–10.

▶ Continue to one of the following procedures.

Setting the routing .....	P. 107
Using mono headphone output .....	P. 107
Monitoring mid-side stereo signals.....	P. 108

## ■ Setting the routing

6. Use ▲ and ▼ to select the tracks/outputs for headphone routing and press ✓.

Setting 1 4.7 USB

1	2	3	4	5	6	L	R	Line
<input type="checkbox"/>	<input type="checkbox"/>	<input type="checkbox"/>	<input type="checkbox"/>	<input type="checkbox"/>	<input type="checkbox"/>	<input checked="" type="checkbox"/>	<input type="checkbox"/>	L
<input type="checkbox"/>	<input type="checkbox"/>	<input type="checkbox"/>	<input type="checkbox"/>	<input type="checkbox"/>	<input type="checkbox"/>	<input checked="" type="checkbox"/>	<input type="checkbox"/>	R
MS MS MS								
<input checked="" type="checkbox"/> Pre	<input type="checkbox"/> Mono							
<input checked="" type="checkbox"/> Post	<input type="checkbox"/> Clear							

Mid-side stereo monitoring

Set all tracks 1–6 to pre-fader (cancel MS)

Press to cycle through settings

- Change tracks 1–6 to post-fader (cancel others)
- Change L/R to post-fader (cancel others)
- Change Line to post-fader (cancel others)
- Change U1–U4 to post-fader (cancel others)

Tracks routed to left headphone channel

Tracks routed to right headphone channel

Mono mix

Clear all settings

Set to post-fader  
 Set to pre-fader  
 Off

### HINT

Press **ENTER** to cycle through the options: prefader → postfader → off.

### NOTE

- L/R and line outputs cannot be set to prefader.
- When AIF with Rec is set to On, USB track 1–4 can be assigned.
- The 1–6, L/R, line outputs and USB track 1–4 cannot be selected at the same time. Selecting one type will deselect any other.

7. Press ⏸.

## ■ Using mono headphone output

6. Use ▲ and ▼ to select Mono, and press ✓.

Setting 1 4.7 USB

1	2	3	4	5	6	L	R	Line
<input type="checkbox"/>	<input type="checkbox"/>	<input type="checkbox"/>	<input type="checkbox"/>	<input type="checkbox"/>	<input type="checkbox"/>	<input checked="" type="checkbox"/>	<input type="checkbox"/>	L
<input type="checkbox"/>	<input type="checkbox"/>	<input type="checkbox"/>	<input type="checkbox"/>	<input type="checkbox"/>	<input type="checkbox"/>	<input checked="" type="checkbox"/>	<input type="checkbox"/>	R
MS MS MS								
<input checked="" type="checkbox"/> Pre	<input checked="" type="checkbox"/> Mono							
<input checked="" type="checkbox"/> Post	<input type="checkbox"/> Clear							

7. Press ⏸.

## ■ Monitoring mid-side stereo signals

Signals from a mid-side stereo mic can be converted to an ordinary stereo signal for monitoring.

6. Use  and  to select MS, and press .

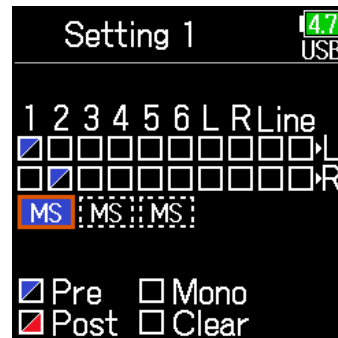

7. Press .



### NOTE

- This is disabled for tracks that have input linking set to MS.
- When mid-side stereo monitoring is enabled, the pre-fader tracks will be routed automatically to the headphone channels, with odd to the left and even to the right. In this case, the routing cannot be changed manually.



# Outputting alerts through headphones

The volume can be adjusted for alerts output from headphones when, for example, recording starts and stops.

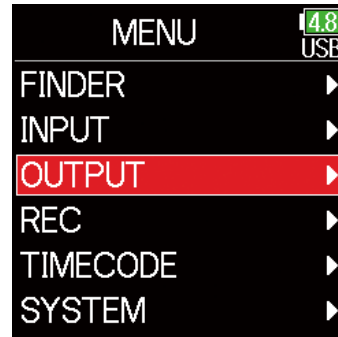

1. Press .

2. Use  and  to select OUTPUT, and press .



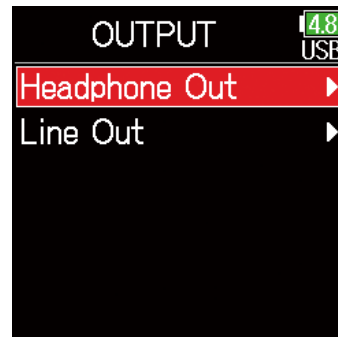

3. Use  and  to select Headphone Out, and press .

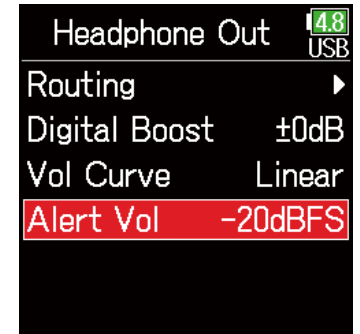

4. Use  and  to select Alert Vol, and press .



5. Use  and  to adjust the volume, and press .

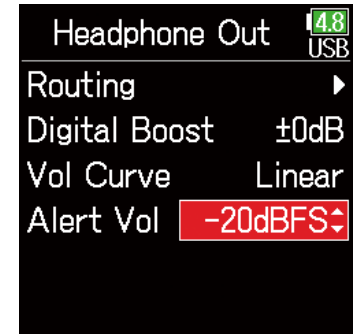

## HINT



- This can be set to Off or between -48 and -12 dBFS.
- When set to Off, no alerts will be output.

When alerts sound	Sound type
Remaining battery low	880Hz tone 4 times every 30 seconds
Recording starts	1000Hz tone 1 time
Recording stops	880Hz tone 2 times
Recording not possible	880Hz tone 3 times



# Setting the headphone output volume curve

The volume curve used when adjusting the headphone volume knob can be set.

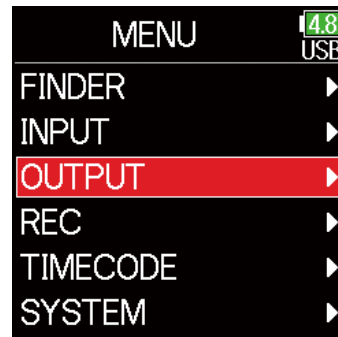

1. Press .

2. Use  and  to select OUTPUT, and press .



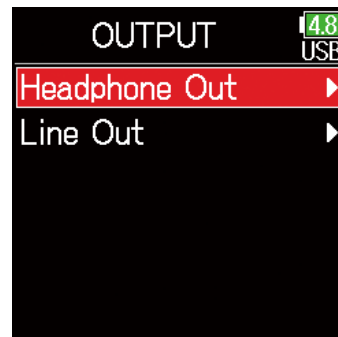

3. Use  and  to select Headphone Out, and press .

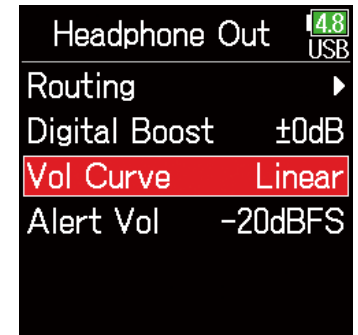

4. Use  and  to select Vol Curve, and press .



5. Use  and  to select a curve, and press .

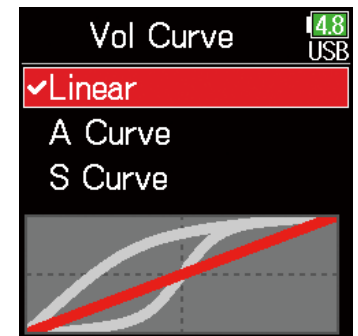



Setting	Explanation
Linear	The volume will change evenly from the minimum value to the maximum value.
A Curve	The closer the volume is to its minimum position, the more rapidly it will change.
S Curve	The closer the volume is to its middle position, the more rapidly it will change.



## Boosting headphone output to alleviate interference from recorded sound

Boosting the headphone output alleviates the interference of sound waves traveling through the air with the headphone monitoring signal, enabling more accurate monitoring of the sound being recorded.

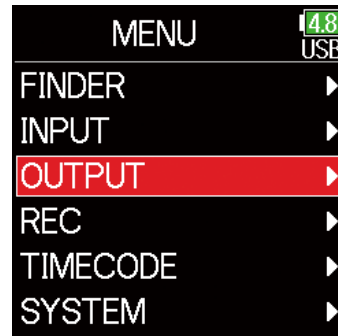

1. Press .

2. Use  and  to select OUTPUT, and press .



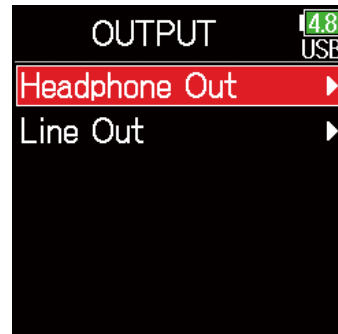

3. Use  and  to select Headphone Out, and press .

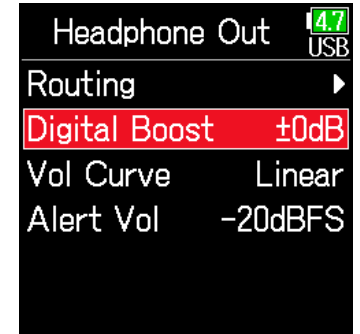

4. Use  and  to select Digital Boost, and press .



5. Use  and  to adjust the boost amount, and press .

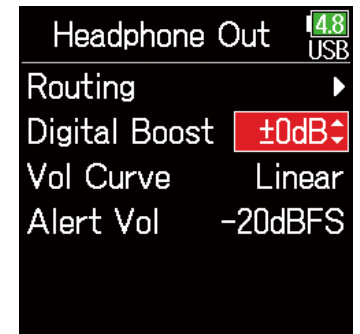

### HINT

The amount of boost can be set from 0 to +24 dB.

**NOTE**

In situations where the sound being recorded can be heard at the headphone monitoring position, sound waves traveling through the air can interfere with the sound heard from the headphones, altering the monitored sound. The more the sound heard through the headphones is delayed and the lower its volume, the greater the impact of the sound waves.



Digital Boost adds a set boost volume to the adjusted headphone volume level, reducing the impact of the sound waves that travel through the air.







# Setting the output level

The Line Out output level can be changed.

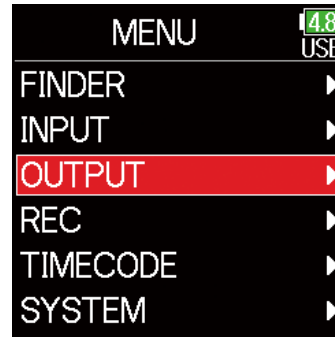

1. Press .

2. Use  and  to select OUTPUT, and press .



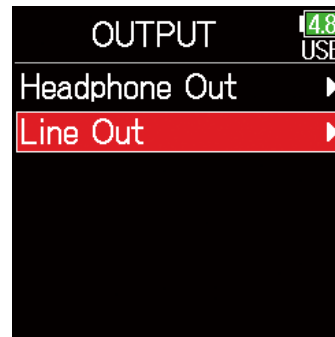

3. Use  and  to select Line Out, and press .

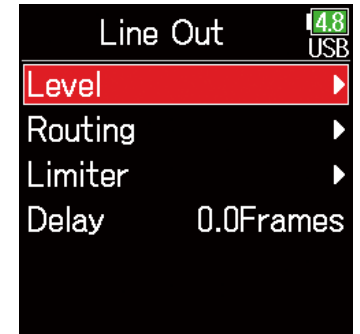

4. Use  and  to select Level, and press .



5. Use  and  to select Line Out, and press .

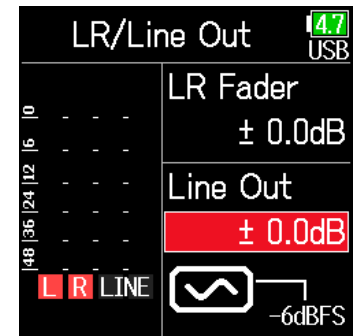

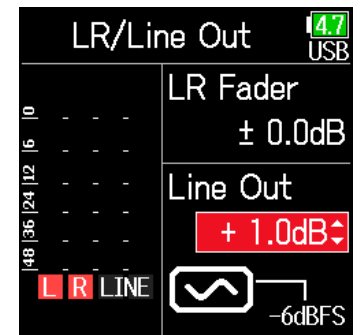

6. Use  and  to adjust the output level, and press .



## HINT

This can be set to Mute or from -48.0 to +12.0 dB

## ■ Adjusting connected equipment levels (playing test tones)

5. Use  and  to select the line output sine wave icon, and press  to play a test tone.

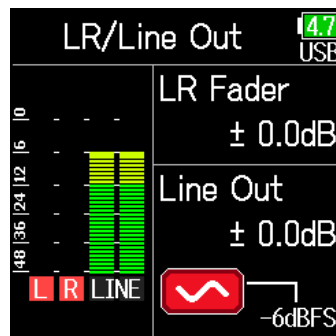

6. Press  to stop test tone playback.

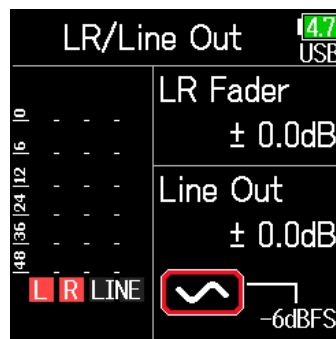

## HINT

- While checking the audio level meter of the connected device, make adjustments to the input gain of that device until the audio signal level is about -6 dB.
- The test tone is a 1kHz sine wave at -6 dBFS.



## NOTE

- See the manual of the connected device for information about its operation.
- If the automatic gain control function on the other device is on, turn it off.
- The test tone is output from both the **LINE OUT** and **HEADPHONE** jacks.
- Be careful with the volume if you are monitoring the sound with headphones, for example.



# Applying delay to the output

By delaying output, timing differences for audio input into another device can be corrected.

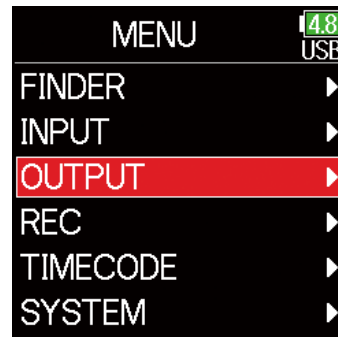

1. Press .

2. Use  and  to select OUTPUT, and press .





3. Use  and  to select Line Out, and press .

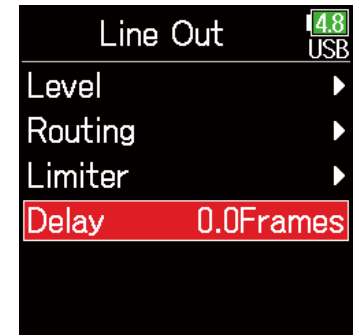

4. Use  and  to select Delay, and press .



5. Use  and  to adjust the delay in frames, and press .

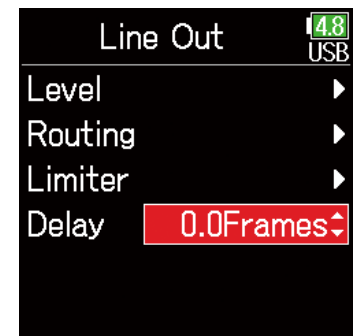

## HINT

This can be set from 0.0 to 10.0 frames.

## NOTE

- Delays in milliseconds differ according to the frame rate of the selected timecode.
- When Sample Rate is set to 192 kHz, Output Delay is disabled.



# Output Limiter

Using a limiter on the output can protect devices connected to the output jacks.



## HINT

For details about the limiter, see “Input limiter” ( → P. 84).

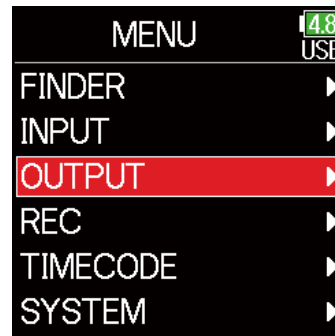

1. Press .

2. Use  and  to select OUTPUT, and press .

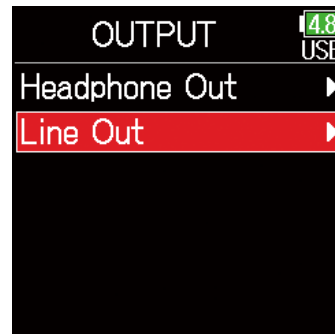

3. Use  and  to select Line Out, and press .



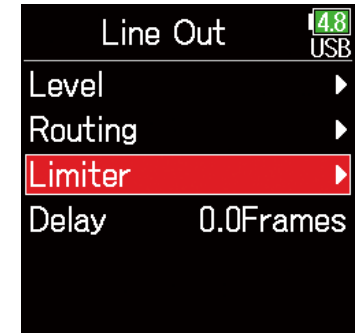

4. Use  and  to select Limiter, and press .



▶ Continue to one of the following procedures.

Using the limiter .....	P. 117
Setting the type .....	P. 117
Setting the threshold .....	P. 118
Setting the attack time .....	P. 118
Setting the release time .....	P. 119
Linking the limiter .....	P. 119

## ■ Using the limiter

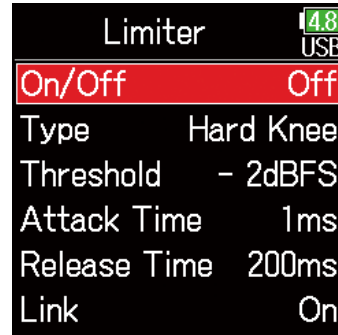

5. Use  and  to select On/Off, and press .



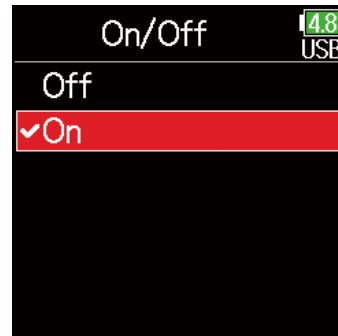



6. Use  and  to select On, and press .

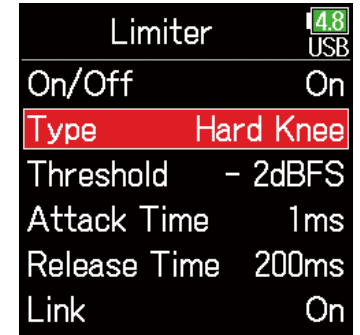

## ■ Setting the type

5. Use  and  to select Type, and press .



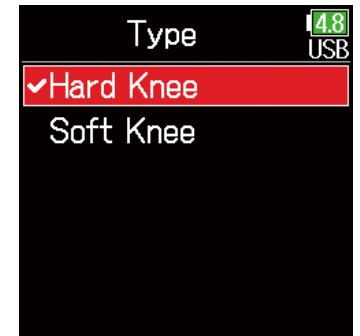

6. Use  and  to select the type, and press .







Setting	Explanation
Hard Knee	Only peaks that exceed the threshold are attenuated. There is no effect below the threshold.
Soft Knee	The limiter gradually affects the signal about 6 dB below the threshold for a gentler effect.



## ■ Setting the threshold

This sets the base level from which the limiter operates.

5. Use  and  to select Threshold, and press .

Limiter 	
On/Off	On
Type	Hard Knee
Threshold	- 2dBFS
Attack Time	1ms
Release Time	200ms
Link	On

6. Use  and  to adjust the setting, and press .



Limiter 	
On/Off	On
Type	Hard Knee
Threshold	- 2dBFS 
Attack Time	1ms
Release Time	200ms
Link	On

### HINT



This can be set from -16 to -2 dBFS.



## ■ Setting the attack time

This sets the amount of time until compression starts after the input signal exceeds the threshold.

5. Use  and  to select Attack Time, and press .

Limiter 	
On/Off	On
Type	Hard Knee
Threshold	- 2dBFS
Attack Time	1ms
Release Time	200ms
Link	On

6. Use  and  to adjust the time, and press .

Limiter 	
On/Off	On
Type	Hard Knee
Threshold	- 2dBFS
Attack Time	1ms 
Release Time	200ms
Link	On

### HINT

This can be set from 1 to 4 ms.

## ■ Setting the release time

This sets the amount of time until compression stops after the input signal goes below the threshold.

5. Use and to select Release Time, and press .

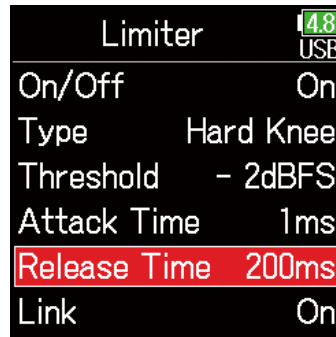

6. Use and to adjust the time, and press .

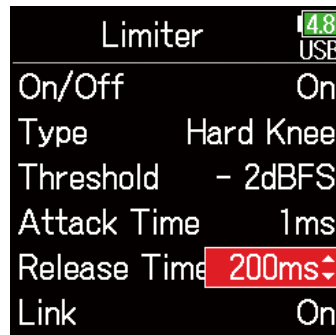

### HINT

This can be set from 1 to 500 ms.

## ■ Linking the limiter

The line output limiters can be linked or applied independently.

5. Use and to select Link, and press .

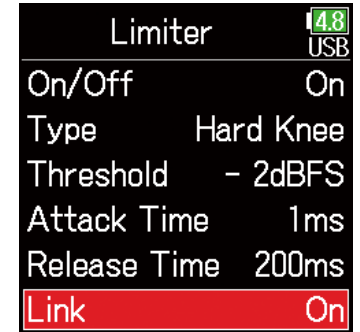

6. Use and to select Off, and press .

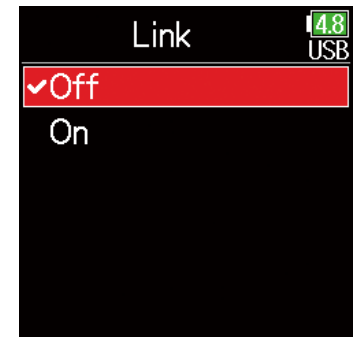



Setting	Explanation
Off	Separate limiter operation.
On	Link limiter operation. If the signal for either linked signal reaches the threshold, the limiter will operate on both channels.



# Selecting signals sent to the line outputs

The type of signal sent to the line outputs can be set to either prefader or postfader for each track.

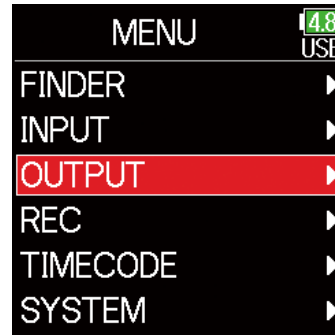

1. Press .

2. Use  and  to select OUTPUT, and press .

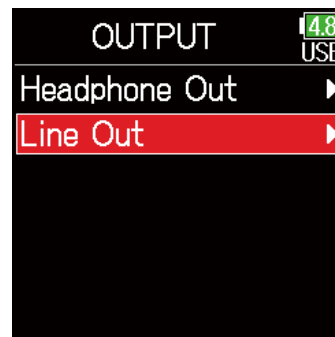

3. Use  and  to select Line Out, and press .



4. Use  and  to select Routing, and press .

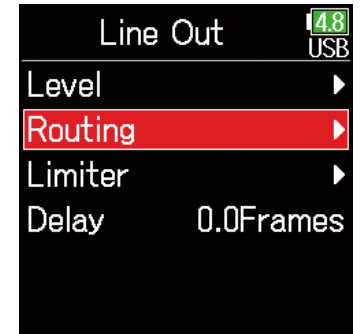

A screenshot of the 'Routing' screen with a '4.8 USB' indicator in the top right. The screen shows a grid for tracks 1-6, L, and R. Below the grid are options for Pre, Post, and Clear. Annotations explain the controls:

- Tracks routed to left line output (indicated by a red triangle in the L column)
- Tracks routed to right line output (indicated by a red triangle in the R column)
- Convert input track stereo signals to mid-side stereo signals for output (indicated by MS labels under tracks 1-3)
- Change tracks 1-6 to pre-fader (indicated by a checked box for Pre)
- Clear all settings (indicated by an unchecked box for Clear)

Press to cycle through settings:

- Change tracks 1-6 to post-fader
- Change L/R tracks to post-fader
- Change U1-U4 tracks 1-6 to post-fader

Legend:

- Set to pre-fader
- Set to post-fader
- Off

## HINT

Press  to cycle through the options: prefader → postfader → off.



## NOTE

- When AIF with Rec is set to On, USB track 1–4 can be assigned.
- Tracks 1–6 can be set to prefader or postfader.
- The L/R tracks can only be set to postfader.
- Tracks 1–6, L/R, and USB 1–4 cannot be set at the same time. Selecting one type will deselect the other.
- When mid-side stereo monitoring is enabled, the pre-fader tracks will be routed automatically to the line output channels, with odd tracks to the left and even tracks to the right. In this case, the routing cannot be changed manually.

---

5. Press .

# Timecode

## Timecode overview

The **F6** can input and output SMPTE timecode.

Timecode is time information written to data when recording video and audio. It is used for video editing, control of other devices, and synchronization of audio and video, for example.

### ■ Using timecode for editing

If video and audio data both have recorded timecode, aligning them to a timeline and synchronizing them together is easy when using nonlinear editing software for editing.

#### HINT

The **F6** uses a high-precision oscillator that enables the generation of accurate timecode with a discrepancy of less than 0.5 frames per 24 hours.

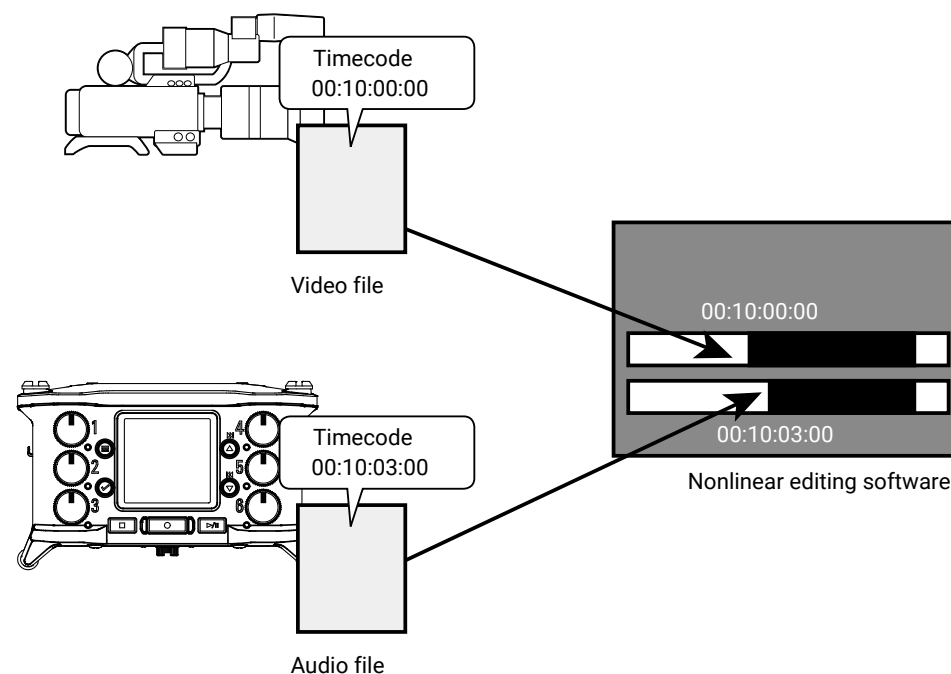

## ■ Connection example

Connections like the following are possible according to application.

### Synchronizing with a video camera

The **F6** records with a mic input and transmits timecode.

The **F6** records the timecode that it generates itself with the audio data. The timecode received by the video camera is recorded with the video data.

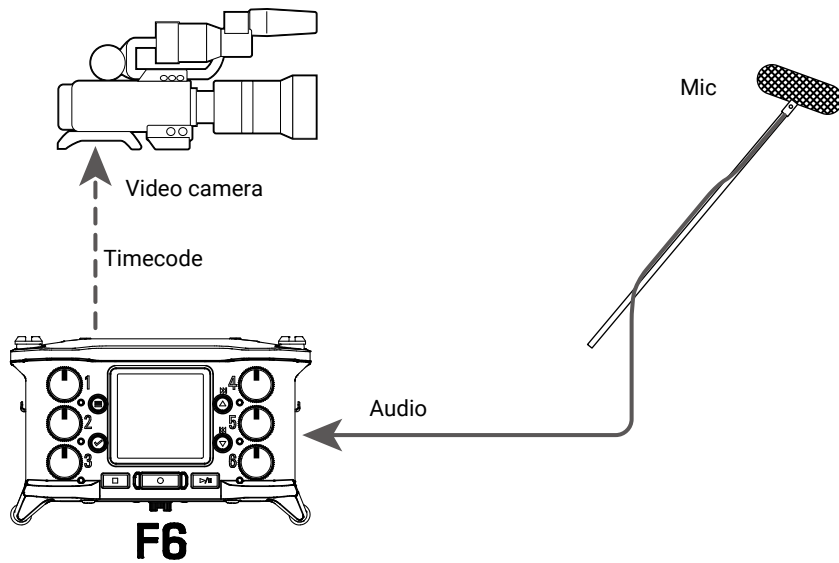

## ■ Inputting timecode

Timecode is transmitted from the timecode generator.

Both the **F6** and the video camera receive timecode and record it with their audio and video data.

The input timecode can also be used to synchronize the audio clock of the **F6**.

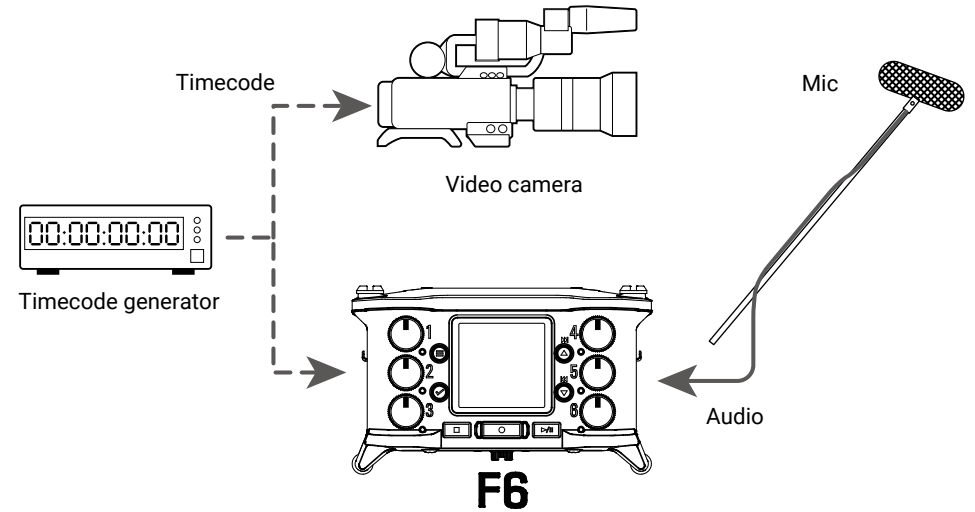

# Setting timecode

1. Press .

2. Use  and  to select TIMECODE, and press .

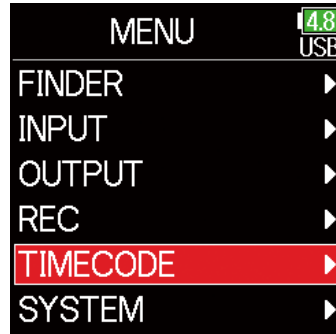

► Continue to one of the following procedures.

Setting the mode .....	P. 125
Synchronizing audio clock with external timecode .....	P. 127
Automatically enabling internal timecode when no external timecode is input .....	P. 127
Setting the user bits for internal timecode .....	P. 128
Setting the frame rate for internal timecode .....	P. 130
Jamming internal timecode .....	P. 131
Restarting internal timecode with a specified value .....	P. 131

Mode	Use to set the timecode mode, timecode output when recording is stopped, synchronization with audio clock, and internal timecode operation when there is no external timecode input.
FPS	Use to set the frame rate of the internal timecode.
Jam	Use to set jamming of the timecode input through the TIMECODE IN/OUT jack by the internal timecode. This can be used to restart the internal timecode at a chosen set value.
Ubits	Use to set the mode and content of user bits that can be included in timecode.
Auto Rec Delay	Use to set the amount of time until recording starts after timecode is received.
Start TC	Use to set the value used when jamming timecode starts and for calibration to increase the precision when jamming to RTC.

## ■ Setting the mode

The following types of settings can be made.

- Whether the **F6** generates timecode or receives external timecode
- Whether timecode continues running or not when not recording

- 3.** Use and to select Mode, and press .

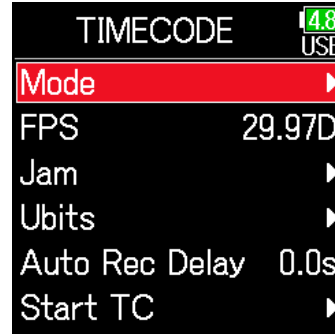

- 4.** Use and to select Mode, and press .

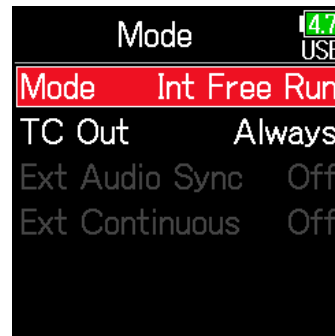

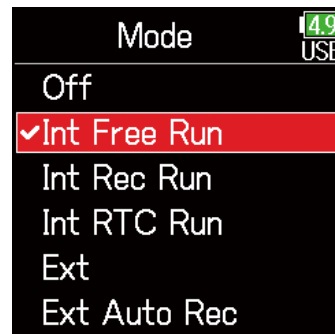

- 5.** Use and to select the mode, and press .







Setting	Explanation
Off	No timecode will be written to the recording file. Timecode will not be output from the TIMECODE IN/OUT jack.
Int Free Run	Internal timecode will be generated regardless of the recording mode. The internal timecode can be set manually using the following menu items. • MENU > TIMECODE > Jam • MENU > TIMECODE > Restart Timecode will always be output from the TIMECODE IN/OUT jack.
Int Rec Run	Internal timecode will be generated only when recording. The internal timecode can be set manually using the following menu items. • MENU > TIMECODE > Jam • MENU > TIMECODE > Restart When switching from another mode, the internal timecode will stop at the last value.
Int RTC Run	Internal timecode will be generated regardless of the recording mode. In the following situations, the internal timecode will be synchronized (jammed) with the RTC (internal clock). • At startup • When Date/Time (RTC) changed ( → P. 18) • When switching to this timecode mode Timecode will always be output from the TIMECODE IN/OUT jack.
Ext	The internal timecode will chase the external timecode. When there is no external timecode, automatic generation of internal timecode can also be enabled. ( → P. 127)
Ext Auto Rec	The internal timecode will chase the external timecode. When there is no external timecode, automatic generation of internal timecode can also be enabled. ( → P. 127) Recording starts automatically when external timecode input is detected. Recording stops automatically when external timecode stops.

## ■ Outputting timecode only when recording

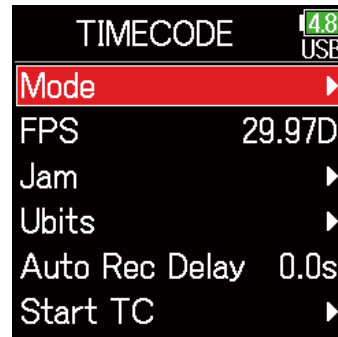

Whether or not timecode is output from the TIMECODE IN/OUT jack when recording is stopped can be set.

3. Use  and  to select Mode, and press .

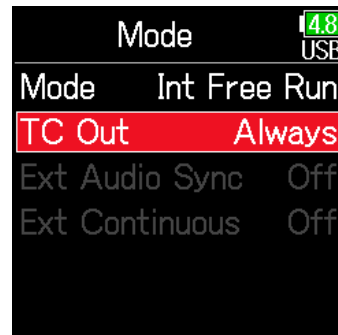

4. Use  and  to select TC Out, and press .



5. Use  and  to select Rec Only, and press .

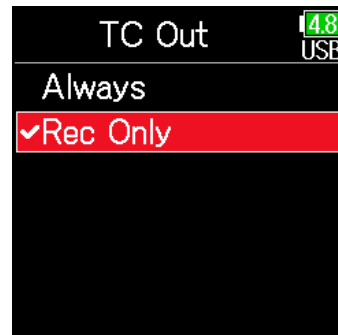

### NOTE

- Timecode will continue to be output when recording/playback is paused.
- This cannot be set when Mode is set to Off, Ext or Ext Auto Rec.

### HINT

Always: Timecode is always output regardless of the recorder status.  
Rec Only: Timecode is output only when recording.

## ■ Synchronizing audio clock with external timecode

3. Use and to select Mode, and press .

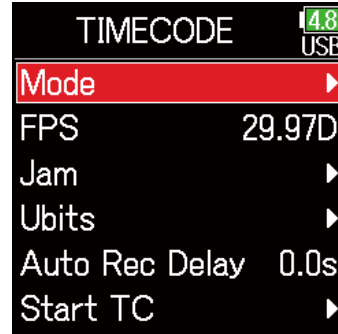

4. Use and to select Ext Audio Sync, and press .

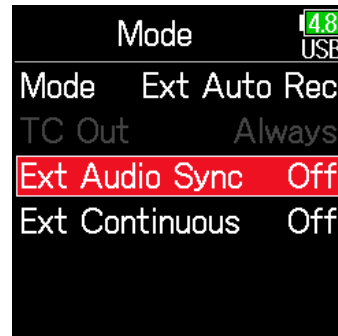

5. Use and to select On, and press .

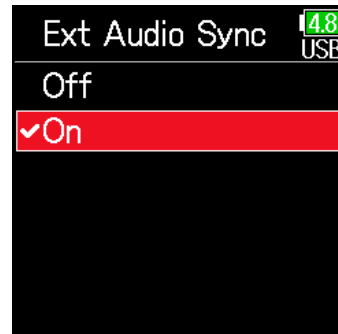

### NOTE

- When there is no external timecode, the internal audio clock is enabled to preserve continuity.
- This cannot be set when Mode is set to Off, Int Free Run, Int Rec Run or Int RTC Run.

## ■ Automatically enabling internal timecode when no external timecode is input

The automatic generation of internal timecode can be enabled to preserve continuity when there is no external timecode.

3. Use and to select Mode, and press .

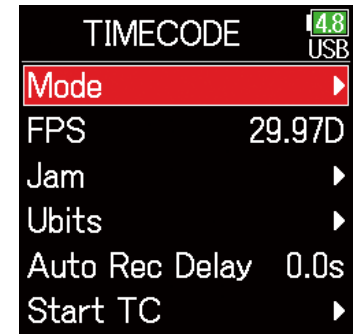

4. Use and to select Ext Continuous, and press .

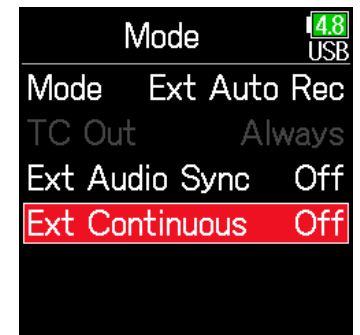

5. Use  and  to select On, and press .

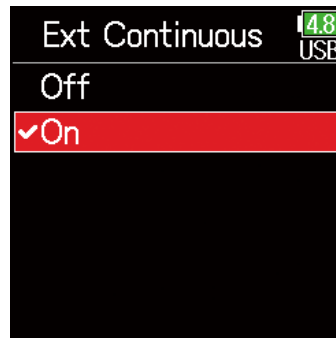



**NOTE**

This cannot be set when Mode is set to Off, Int Free Run, Int Rec Run or Int RTC Run.



■ **Setting the user bits for internal timecode**

User bits are data that can be set for inclusion in the timecode. Up to 8 numbers (0–9) and letters (A–F) can be included. Recording date information, for example, can be useful when editing later.

**Setting the user bits (Ubits) mode**

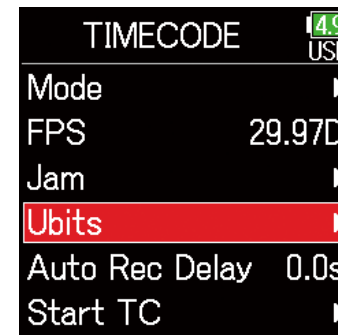

3. Use  and  to select Ubits, and press .



4. Use  and  to select Mode, and press .





5. Use  and  to select the mode, and press .

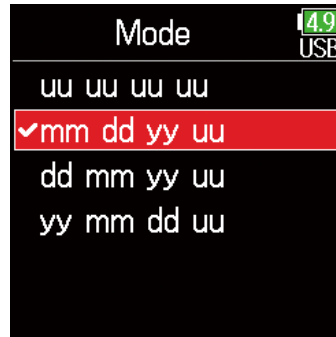



Setting	Explanation
uu uu uu uu	These values can be set as desired on the <b>Edit</b> screen.
mm dd yy uu	The month, day and year are entered automatically in that order using the RTC setting. The "uu" value can be set as desired on the Edit screen.
dd mm yy uu	The day, month and year are entered automatically in that order using the RTC setting. The "uu" value can be set as desired on the Edit screen.
yy mm dd uu	The year, month and day are entered automatically in that order using the RTC setting. The "uu" value can be set as desired on the Edit screen.



**HINT**

Only "uu" items can be changed.

■ **Setting the user bits (Ubits)**

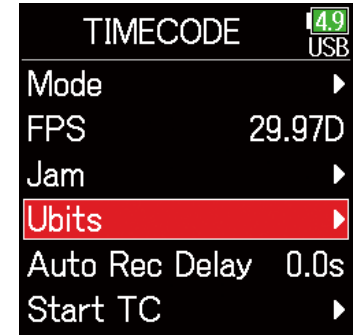
3. Use  and  to select Ubits, and press .



4. Use  and  to select Edit, and press .

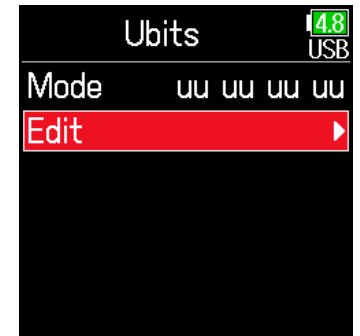

5. **Edit the value.**

Move cursor or change value:

Use  and 

Select parameter to edit:

Press 

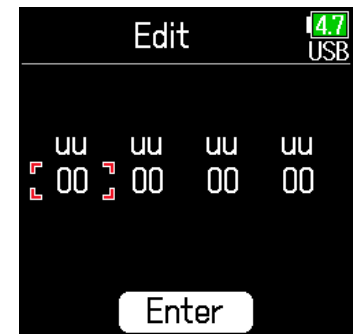

**HINT**

This can be set using numbers from 0 to 9 and letters from A to F.

6. When done setting, use and to select Enter, and press .

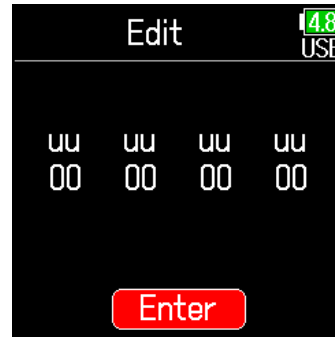

### Setting the frame rate for internal timecode

3. Use and to select FPS, and press .

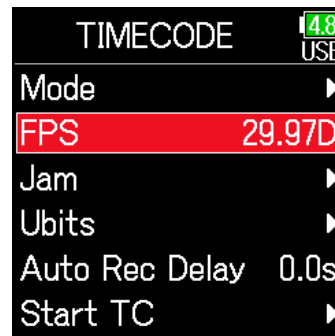

4. Use and to select the frame rate, and press .

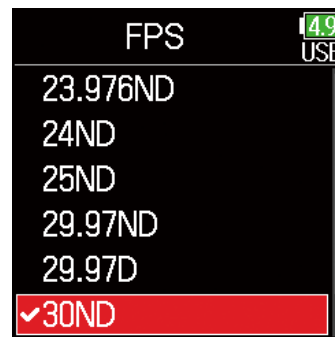

Setting	Explanation
23.976ND	This is the most common frame rate used with HD cameras and other high-definition video recording. The count is slower than the actual time by 0.1%.
24ND	This is the standard frame rate used for recording film. This is also used with HD cameras.
25ND	This is the frame rate for PAL video. This is used for PAL video, which is used in Europe and other regions.
29.97ND	This is a frame rate used for NTSC color video and HD cameras. The count is slower than the actual time by 0.1%. This is used for NTSC video, which is used in Japan, the United States and other countries.
29.97D	This is an adjusted frame rate that uses a drop frame to make NTSC match the actual time. This is used with video for broadcast that requires the actual time frame to be matched.
30ND	This is used to synchronize sound with film that is being transferred to NTSC video. This is the standard frame rate used for black-and-white television in Japan, the United States and other countries.
30D	This rate is used for special applications. This synchronizes at 29.97 fps drop frame with film sound to be transferred to NTSC. The count is faster than the actual time by 0.1%.

#### NOTE

Frame rates must be set in advance to match on devices used for all video and audio data.

## ■ Jamming internal timecode

Timecode input through the TIMECODE IN jack is used to set internal timecode

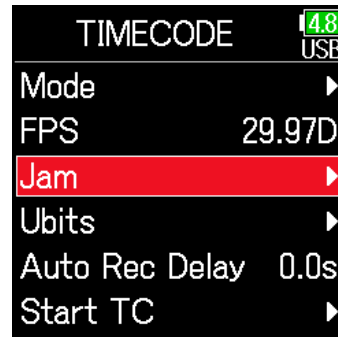

3. Use  and  to select Jam, and press .



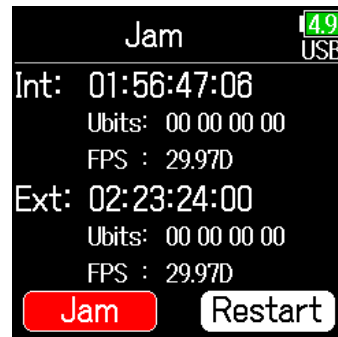



4. Use  and  to select Jam, and press .

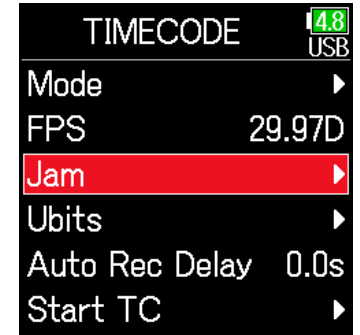

## ■ Restarting internal timecode with a specified value

3. Use  and  to select Jam, and press .



4. Use  and  to select Restart, and press .

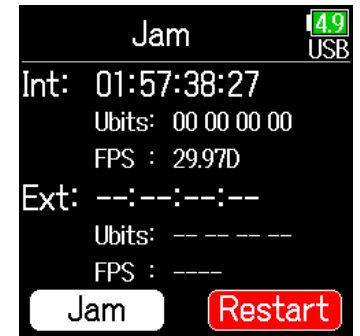

5. Set the restart value.



Move cursor or change value:

Use  and 

Select parameter to edit:

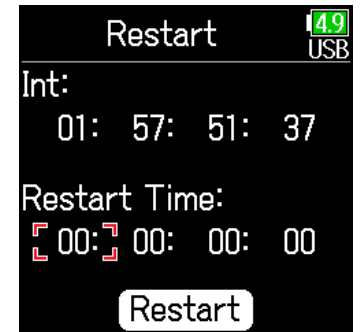
Press 



6. Use  and  to select Restart, and press .







## Setting the automatic timecode recording delay

If set to record automatically when external timecode is received, unnecessary recording could occur if timecode is received for a brief amount of time. In order to prevent this, the amount of time until recording starts after timecode is received can be set.

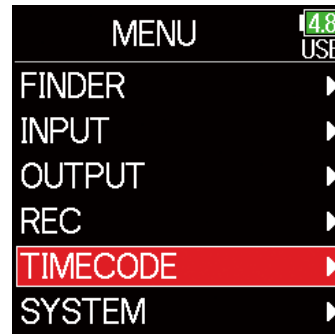

1. Press .

2. Use  and  to select TIMECODE, and press .

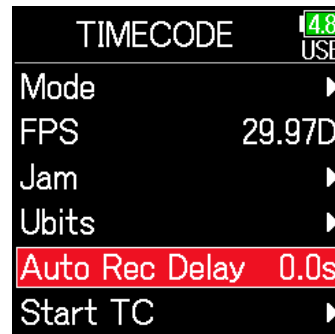

3. Use  and  to select Auto Rec Delay, and press .



4. Use  and  to adjust the time, and press .

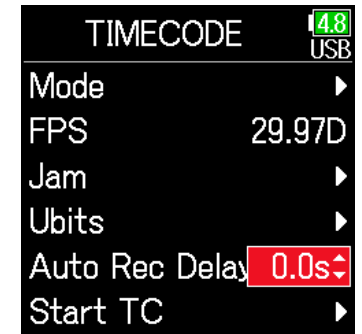

### HINT

This can be set from 0.0 to 8.0 s.

# Setting timecode initialization used at startup

When the **F6** is turned off, the internal timecode stops, so the timecode is automatically initialized (jammed) during startup. The value that is used for jamming at that time can be set.

1. Press .

2. Use  and  to select TIMECODE, and press .

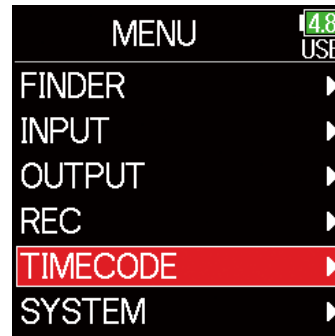

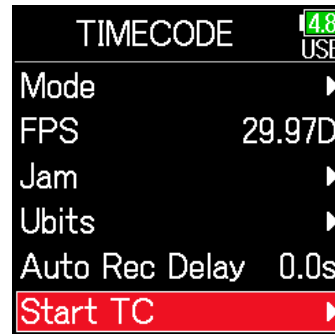

3. Use  and  to select Start TC, and press .







▶ Continue to one of the following procedures.

- Setting how timecode is initialized at startup (Start Timecode) ..... P. 134
- Correcting timecode errors after the power has been turned off..... P. 135

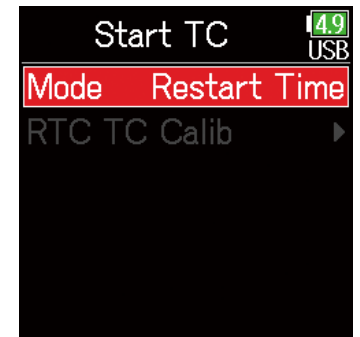
## Setting how timecode is initialized at startup

4. Use  and  to select Mode, and press .



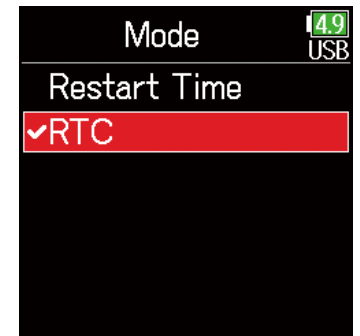

5. Use  and  to set how timecode is initialized, and press .



Setting	Explanation
Restart Time	When the <b>F6</b> starts, the value set by Restart ( → P. 131) is used to jam the internal timecode.
RTC	When the <b>F6</b> starts, its timecode is restored from the timecode when the power was turned off and advanced by the elapsed time using the Date/Time (RTC) setting ( → P. 18). Since RTC is less precise than internal timecode, discrepancies will occur.

## ■ Correcting timecode errors after the power has been turned off

When the Start TC Mode is set to RTC, timecode precision will decrease if the power is turned off. This function can be used to improve precision to almost 0.2 ppm even if the power is turned off.

4. Use  and  to select RTC TC Calib, and press .

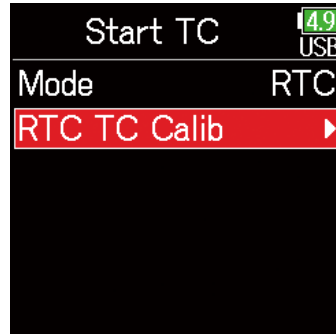



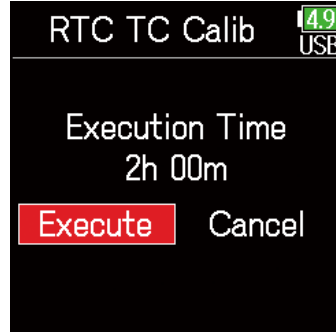

5. Use  and  to select Execute, and press .



6. Calibration completes.



7. To cancel calibration, press . Then, use  and  to select Exit, and press .

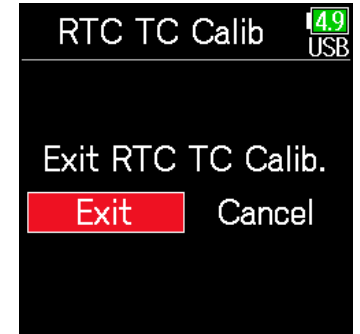

### NOTE

- The **F6** is calibrated before being shipped new from the factory.
- After calibrating once, the result will be retained.
- If the **F6** is moved to and used in an extremely hot or cold location, timecode precision could change slightly when the power is turned off. In such cases, we recommend calibrating it again.
- Calibration is not possible when AIF with Rec is set to On.
- Calibration is only possible when Start TC Mode is set to RTC.
- Calibration is not possible when the **FRC-8** is connected.



# Using USB functions

## Exchanging data with a computer

By connecting with a computer, data on the cards can be checked and copied.

### ■ Connecting

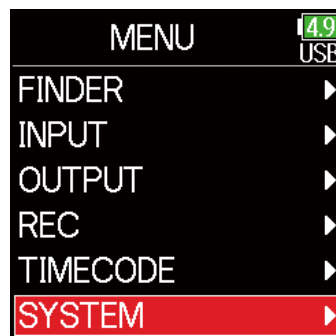

1. Press .

2. Use  and  to select SYSTEM, and press .

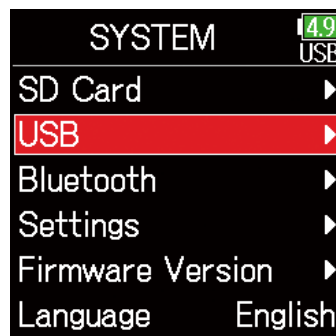

3. Use  and  to select USB, and press .



4. Use  and  to select SD Card Reader, and press .

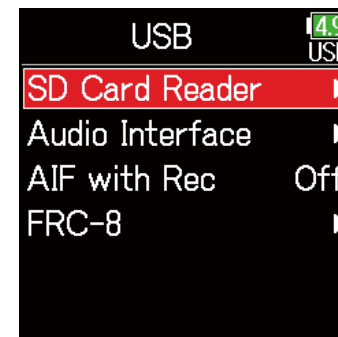

5. Use a USB cable to connect the **F6** and the computer.

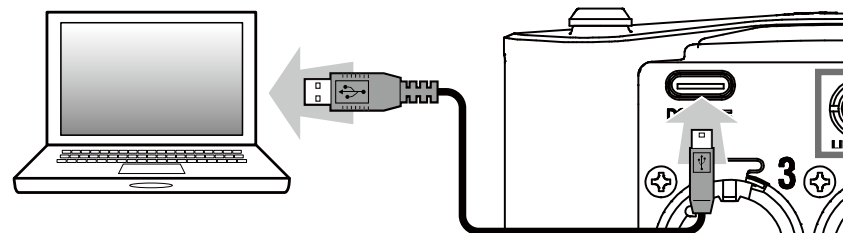

### NOTE

The supported operating systems are as follows.

Windows: Windows 7 or later

macOS: Mac OS X 10.8 or later



## ■ Disconnecting

### 1. Disconnect on the computer.

Windows:

Select **F6** with "Safely Remove Hardware".

macOS:

Drag the **F6** icon to the Trash and drop it.

#### NOTE

Always conduct computer disconnection procedures before removing the USB cable.

---



### 2. Disconnect the cable from the computer and the **F6**, and press .

# Using as an audio interface

**F6** input signals can be input directly to a computer or iOS device, and playback signals on a computer or iOS device can be output from the **F6**.

## ■ Connecting

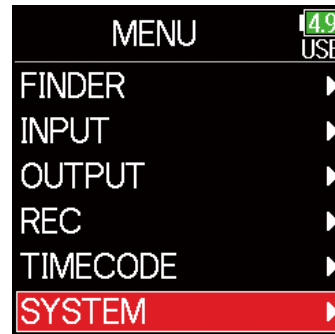

1. Press .

2. Use  and  to select SYSTEM, and press .



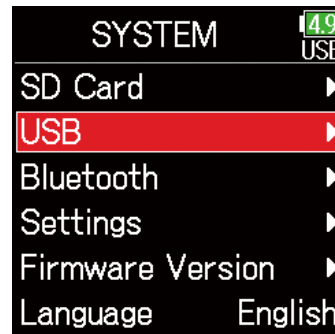

3. Use  and  to select USB, and press .

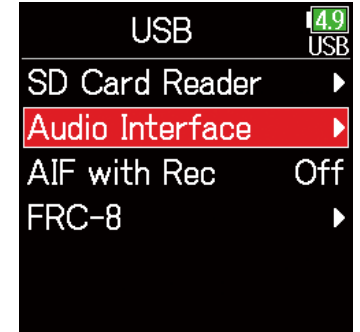

4. Use  and  to select Audio Interface, and press .



5. Use  and  to select the mode and connected device, and press .

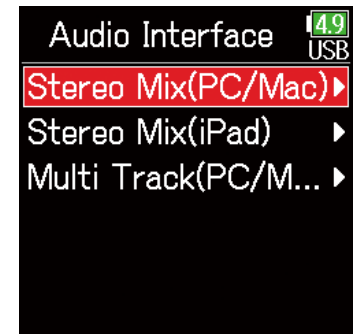

Setting	Explanation
Stereo Mix (PC/Mac)	This is a 2-in/2-out connection mode for Mac/Windows and sends tracks 1–6 as a stereo mix.
Stereo Mix (iPad)	This is a 2-in/2-out connection mode for iOS devices and sends tracks 1–6 as a stereo mix.
Multi Track (PC/Mac)	This is a 6-in/4-out connection mode for Mac/Windows and sends tracks 1–6 as separate signals (cannot be used with iOS devices). A driver is necessary for use with Windows. Download the driver from the ZOOM website ( <a href="http://www.zoom.co.jp/">www.zoom.co.jp/</a> ).

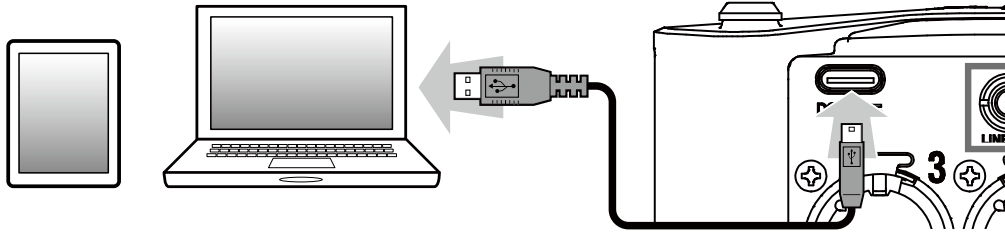

6. Use a USB cable to connect the F6 with the computer or iOS device.

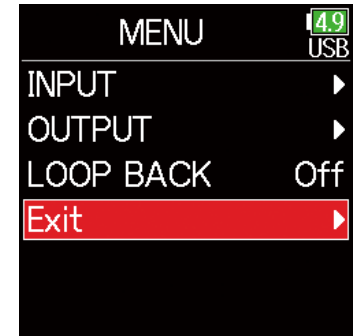

## ■ Disconnecting

1. Press .
2. Use  and  to select Exit, and press .



3. Use  and  to select Exit, and press .





4. Disconnect the cable from the computer or iOS device and the F6.

# Using SD card recording and audio interface functions at the same time

In addition to SD card recording, a computer can also be used to record a backup.

## ■ Connecting

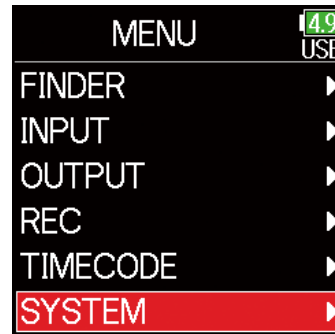

1. Press .

2. Use  and  to select SYSTEM, and press .

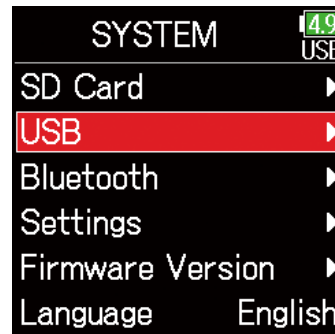

3. Use  and  to select USB, and press .



4. Use  and  to select AIF with Rec, and press .

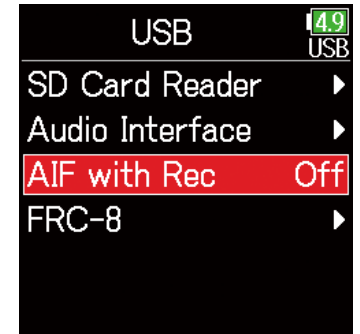

5. Use  and  to select On, and press .

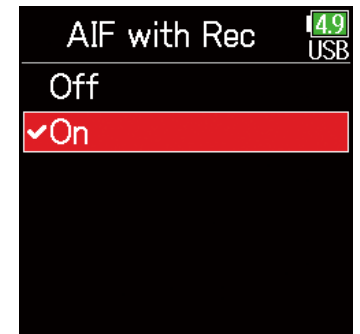

6. Use a USB cable to connect the **F6** and the computer.

## NOTE

- AIF with Rec cannot be used with the following settings and functions.
  - Sample rate settings other than 44.1/48 kHz
  - SD card reader ( → P. 136)
  - Audio interface ( → P. 138)
- **FRC-8** ( → P. 143)
- A driver is necessary for use with Windows. Download the driver from the ZOOM website ([www.zoom.co.jp/](http://www.zoom.co.jp/)).
- When **AIF with Rec** is set to **On**, the sample rate cannot be changed.
- When **AIF with Rec** is set to **On**, files with sample rates that differ from the **F6** setting cannot be played.
- Set the input source to USB1-4 to monitor sound played back from the computer ( → P. 78) or select USB1-4 in the output routing ( → P. 106, P. 109, P. 110).

## ■ Disconnecting

1. Press .
2. Use  and  to select Off, and press .

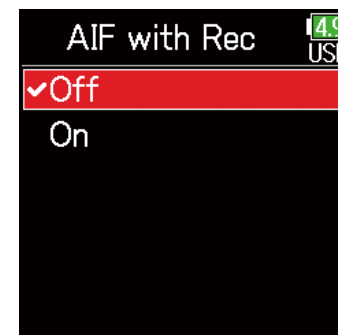

3. Disconnect the cable from the computer and the **F6**.

# Audio interface settings



The following settings can be made when using the **F6** as an audio interface.

## ■ Setting loop back (Stereo Mix only)

This function mixes the playback sound from the computer or iOS device with the **F6** input and sends the mix back to the computer or iOS device (loop back).

This function can be used to add narration to music played back from the computer and to record the mix or stream it on the computer, for example.

1. Press .

2. Use  and  to select LOOP BACK, and press .

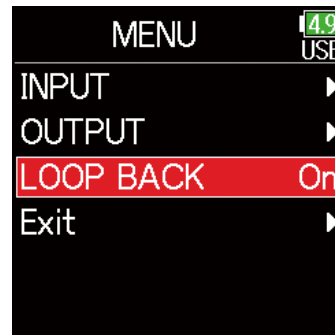

3. Use  and  to select On, and press .

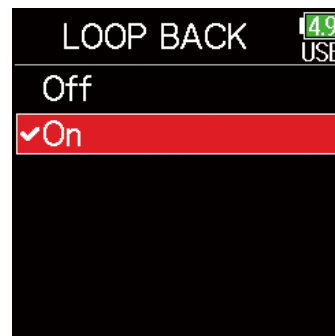

## ■ Mixing inputs

The mix balance of the inputs can be adjusted. Input signals will be sent to the computer or iOS device using the balance settings made here. When using a Stereo Mix setting, the mixed stereo signal will be sent.

1. Open the mixer on the Home Screen ( → P. 10).

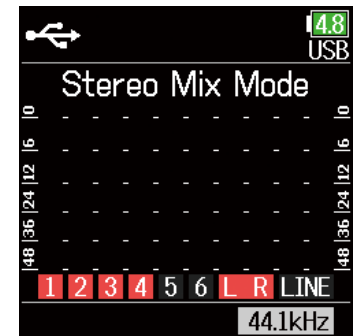

2. Adjust the parameter settings.

See "Adjusting the input signal monitoring balance" ( → P. 76) for how to change settings.



## Using an FRC-8 as a controller

When an **FRC-8** is connected to the **F6**, it can be used to adjust settings, including trim, fader and pan.

### NOTE

An **FRC-8** cannot be used when operating with AA batteries. When multiple power supplies are connected to an **F6**, the power supply being used will automatically change according to the remaining battery charge. When it switches to AA batteries, connection with an **FRC-8** will be interrupted.

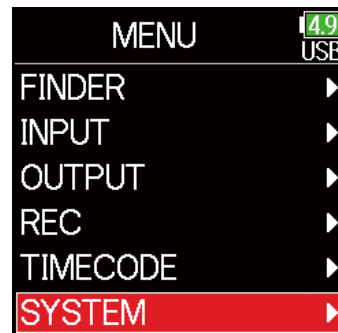

1. Press .

2. Use  and  to select SYSTEM, and press .



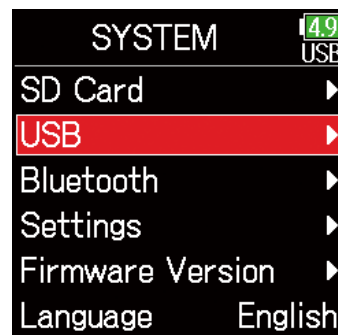

3. Use  and  to select USB, and press .

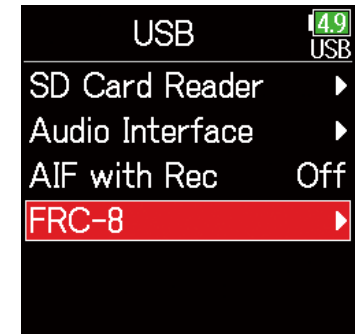

4. Use  and  to select FRC-8, and press .



5. Use  and  to select Connect, and press .

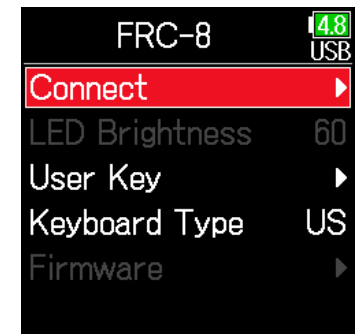

6. Use a USB cable to connect the **F6** and the **FRC-8**.

7. Turn the **FRC-8** power on.

#### NOTE

- When disconnecting the **FRC-8**, select **Disconnect** before unplugging the USB cable
- Select Connect and press  to supply bus power from the **F6** USB port. When bus power is being supplied, do not connect any device other than the **FRC-8**. Doing so could damage the **F6** or a connected device.

#### HINT



When an **F6** and an **FRC-8** are connected, the **FRC-8** will always operate on USB bus power. AA batteries and DC power supply connected to the it are disabled.





# Setting the type of keyboard connected to the FRC-8

A PC keyboard can be connected to the **FRC-8** and used to input characters.  
Set the type to use the PC keyboard connected to the **FRC-8**.

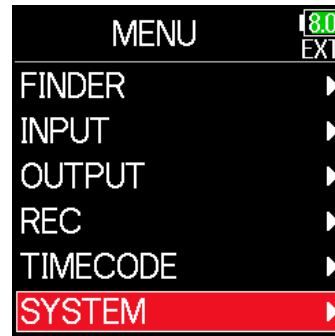

1. Press .

2. Use  and  to select SYSTEM, and press .



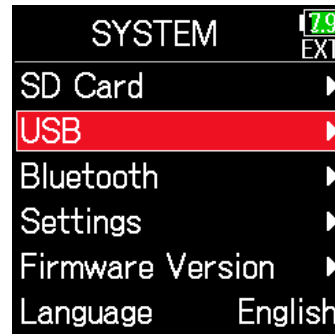

3. Use  and  to select USB, and press .



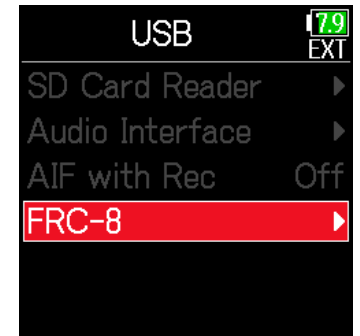

4. Use  and  to select FRC-8, and press .

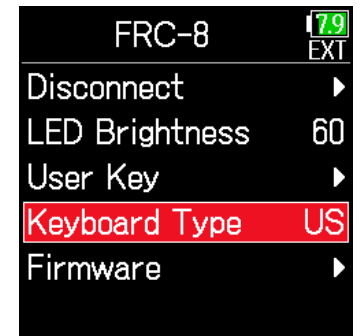

5. Use  and  to select Keyboard Type, and press .



6. Use  and  to select the type, and press .

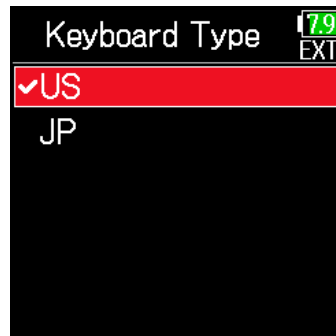



Setting	Explanation
US	This setting is for English-language keyboards.
JP	This setting is for Japanese keyboards.

# Setting user keys for the FRC-8

Functions can be assigned to the **FRC-8** user keys.

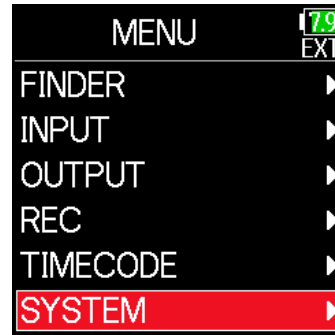

1. Press .

2. Use  and  to select SYSTEM, and press .



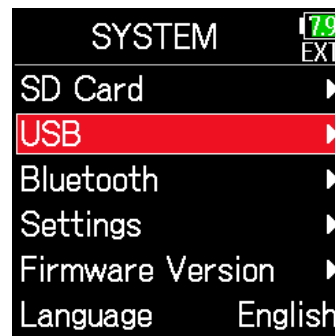

3. Use  and  to select USB, and press .



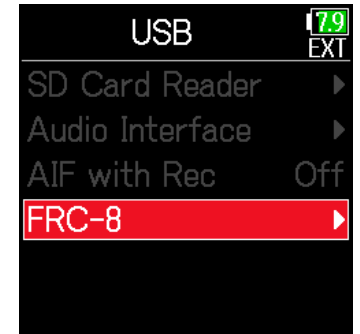

4. Use  and  to select FRC-8, and press .

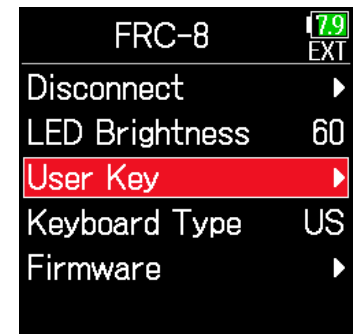

5. Use  and  to select User Key, and press .



6. Use  and  to select the key to which to assign a function, and press .

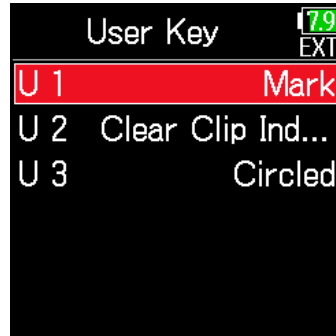

7. Use  and  to select the function to assign, and press .

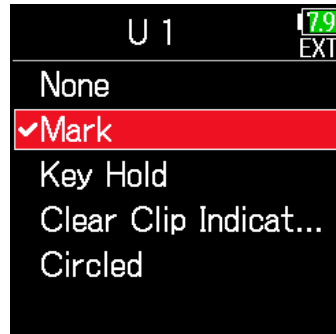



Setting	Explanation
None	No function is assigned.
Mark	Add marks to WAV format takes during recording and playback.
Key Hold	Use to disable the controls set with Key Hold Target.
Clear Clip Indicator	Clear the level meter clipping indicators.
Circled	Circle the currently selected take.

# Setting the FRC-8 LED brightness

The brightness of the LEDs on the front of the **FRC-8** can be adjusted.

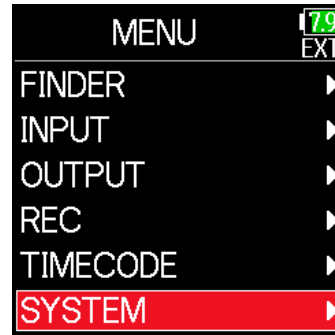

1. Press .

2. Use  and  to select SYSTEM, and press .



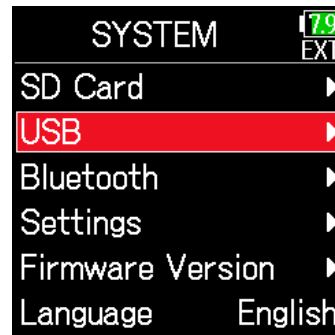

3. Use  and  to select USB, and press .



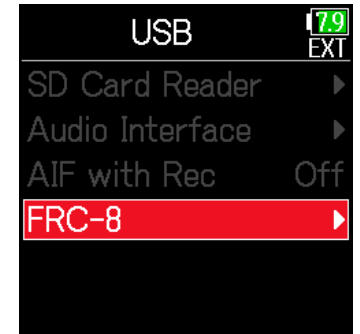

4. Use  and  to select FRC-8, and press .

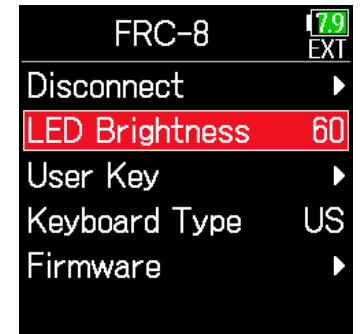

5. Use  and  to select LED Brightness, and press .



6. Use  and  to adjust the brightness, and press .

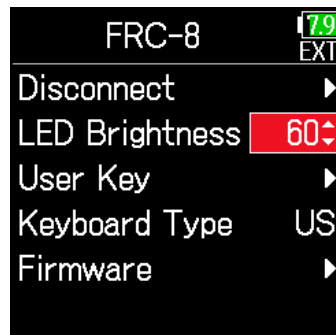

**HINT**

This can be set from 5 to 100.

# Updating the FRC-8 firmware

The **FRC-8** firmware version can be checked and updated to the latest version.  
The latest update file can be downloaded from the ZOOM website (www.zoom.co.jp).

1. See "Using an **FRC-8** as a controller" ( → P. 143), and connect the **F6** and the **FRC-8**.



## NOTE

Updating is not possible if the remaining battery or DC power supply charge is low. In this case, replace the batteries with new ones or use a charged DC power supply.

2. Copy the update file to the root directory on an SD card.

3. Load the SD card into the SD slot.

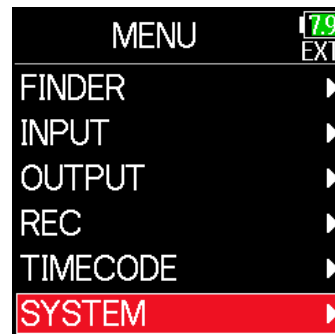

4. Press .

5. Use  and  to select **SYSTEM**, and press .

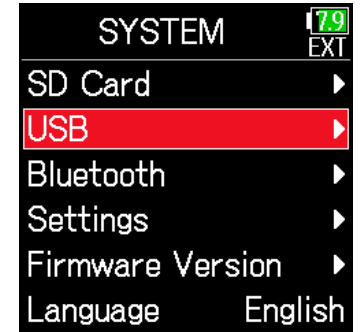

6. Use  and  to select **USB**, and press .



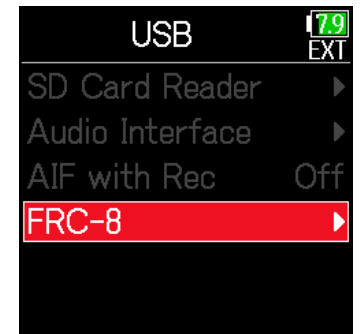

7. Use  and  to select **FRC-8**, and press .







▶ Continue to one of the following procedures.

Checking the firmware versions .....	P. 152
Updating the firmware .....	P. 152

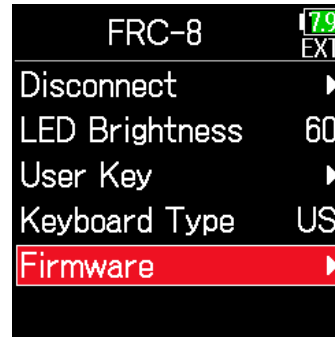
## ■ Checking the firmware versions



8. Use  and  to select Firmware, and press .



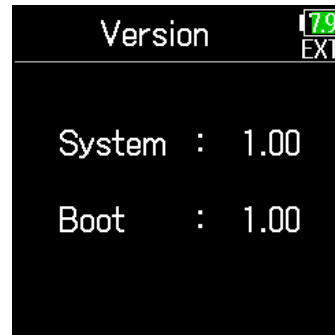



9. Use  and  to select Version, and press .



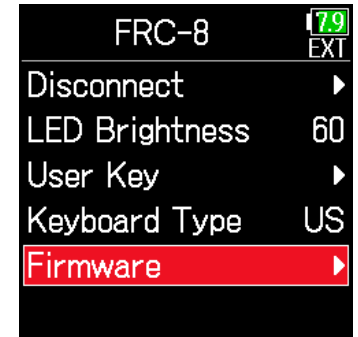

## ■ Updating the firmware

8. Use  and  to select Firmware, and press .



9. Use  and  to select Update, and press .



10. Use  and  to select Update, and press .

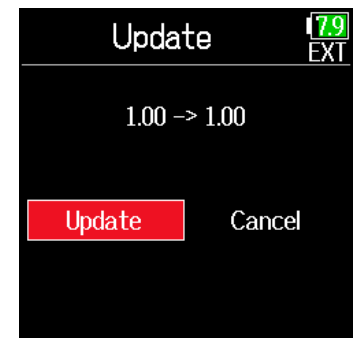



## NOTE

Do not turn the power off, remove an SD card or disconnect the USB cable during an update. Doing so could cause the **FRC-8** to become unstartable.

11. After the update completes, turn the **FRC-8** power off.

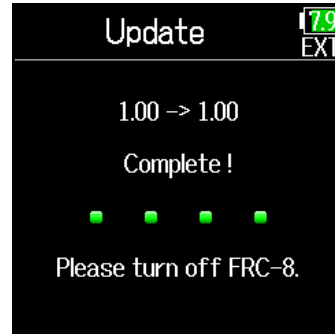

## Operating with an iOS device

### ■ Pairing with an iOS device

By connecting a ZOOM wireless adapter (e.g. BTA-1) and using the dedicated controller app, the **F6** can be operated from an iOS device.



#### NOTE

- The dedicated app must be installed on the iOS device beforehand. The dedicated app can be downloaded from the App Store.
- See the manual for the app for procedures to set and operate it.
- The **F6** can only be paired to one iOS device. Pairing a different iOS device will make it no longer possible to connect with the previously paired iOS device.
- Trying to connect the previous iOS device will cause an error message to appear on the **F6** display and turn the BTA-1 off.
- To reconnect a previously paired iOS device, follow the instructions in the operation manual for the iOS device that you are using to remove the **F6** that is registered as a Bluetooth device.
- Then, after you launch F6 Control, the password input screen will appear, making pairing possible.

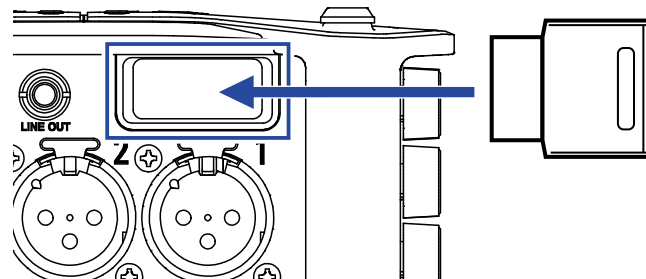

1. Remove the wireless adapter connector cover and connect the wireless adapter.





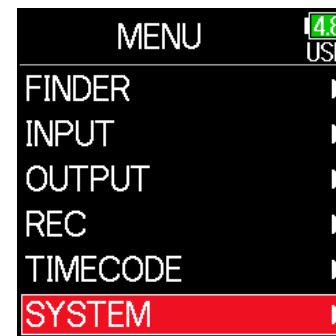

2. Press .

3. Use  and  to select SYSTEM, and press .

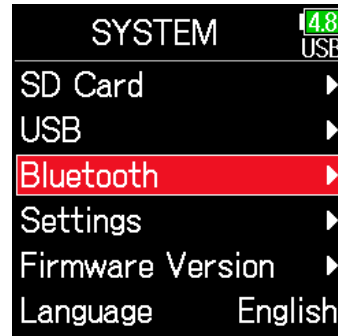



4. Use  and  to select Bluetooth, and press .

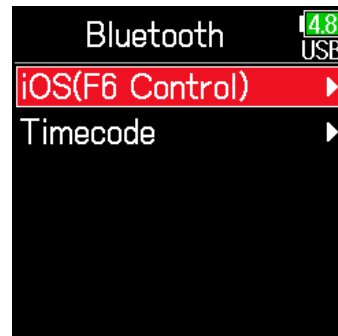

5. Use  and  to select iOS (F6 Control), and press .



6. Use  and  to select Connect, and press .
- A password that is used to identify the ZOOM wireless adapter (e.g. BTA-1) will be shown.



7. Launch the dedicated app on the iOS device, and enter the password shown on the F6 display.
- This starts pairing.
- When pairing completes, "Connected" will appear on the F6 Control screen.

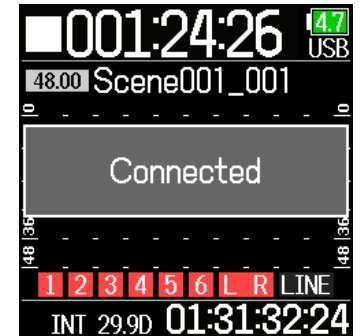



#### HINT



- Entering a password will not be necessary when launching the app again in the future.
- Use the **F6** and the iOS device as close together as possible to make communication more reliable.
- Disconnecting from an iOS device

## ■ Disconnecting from an iOS device

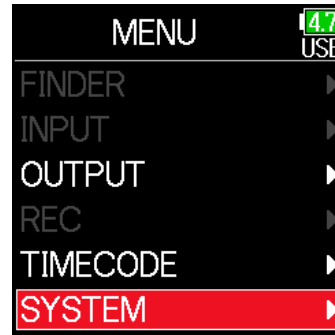

1. Press .

2. Use  and  to select SYSTEM, and press .



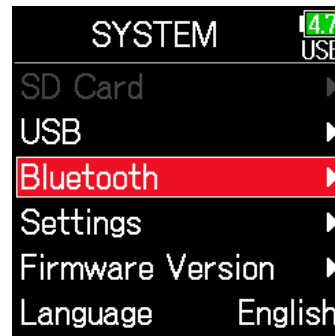

3. Use  and  to select Bluetooth, and press .

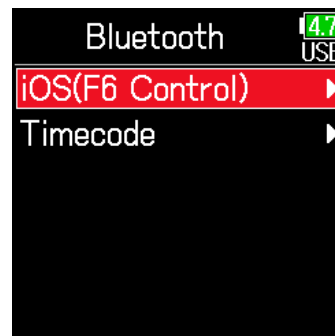

4. Use  and  to select iOS (F6 Control), and press .



5. Use  and  to select Disconnect, and press .

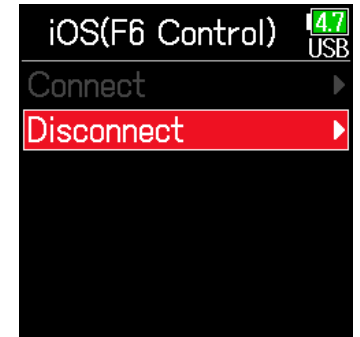

### HINT

After disconnecting, to control the **F6** with the iOS device again, select Menu > System > Bluetooth > iOS (F6 Control) > Connect again.



## ■ Connecting with an UltraSync BLUE

If the **F6** is connected to an UltraSync BLUE, it can receive timecode from the UltraSync BLUE and add it to recording files.

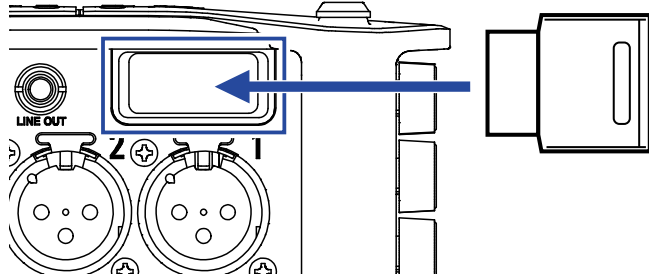

1. Remove the wireless adapter connector cover and connect the wireless adapter.





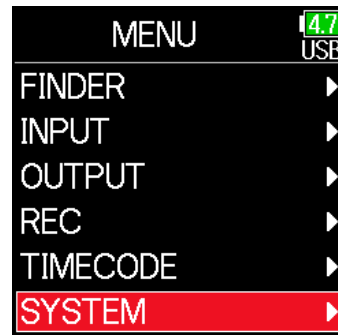

2. Press .

3. Use  and  to select SYSTEM, and press .

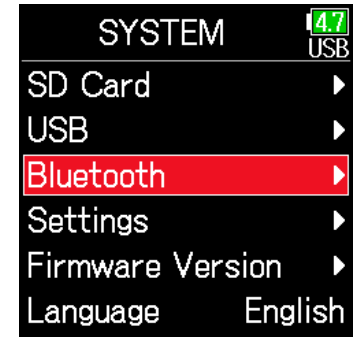



4. Use  and  to select Bluetooth, and press .

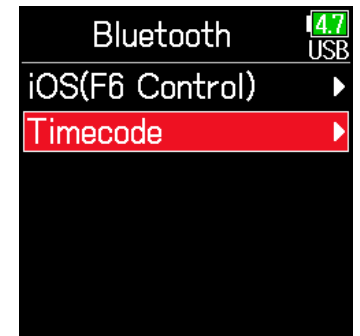

5. Use  and  to select Timecode, and press .



6. Use  and  to select Connect, and press .  
Searching for the connected device will begin and "Searching" will appear on the display.

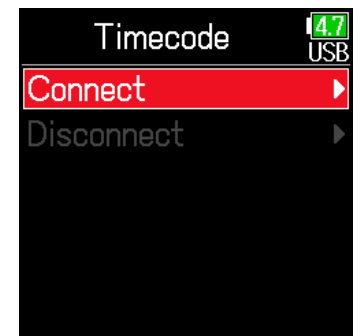

### HINT

- Searching can be canceled by pressing any button.
- After canceling searching, it can be restarted by selecting Menu > Timecode > Pair/Forget > Pair again.

## 7. Select the **F6** as a connected device on the UltraSync BLUE.

When pairing completes, "Connected" will appear on the **F6** display.

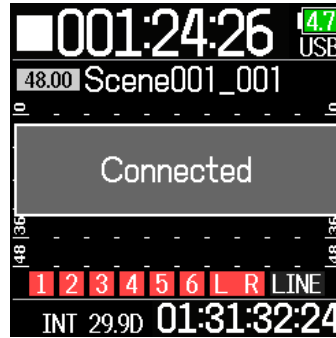



### HINT

- See the UltraSync BLUE manual for the procedures to select connected devices.
- Use the **F6** and the UltraSync BLUE as close together as possible to make communication more reliable.
- Even if communication with the UltraSync BLUE is interrupted, timecode generated by the **F6** will be added to recording files.



## Disconnecting from an UltraSync BLUE

Disconnect the **F6** and the UltraSync BLUE to stop recording timecode from it. Pairing information will be retained even when disconnected.

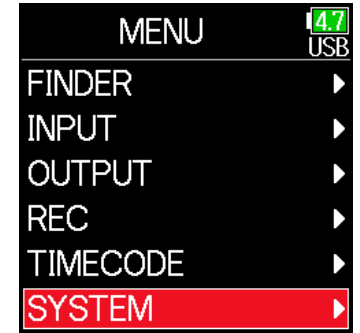

1. Press .

2. Use  and  to select SYSTEM, and press .

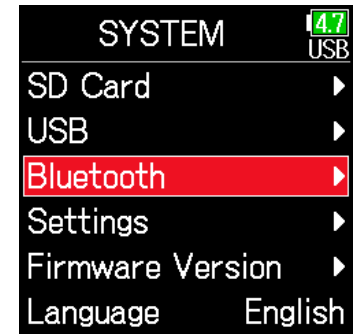

3. Use  and  to select Bluetooth, and press .



4. Use  and  to select Timecode, and press .

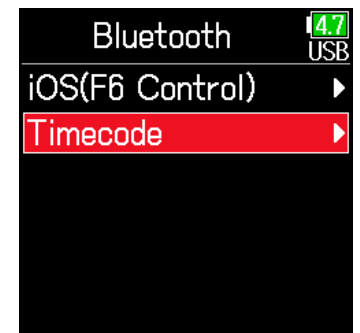

5. Use and to select Disconnect, and press .

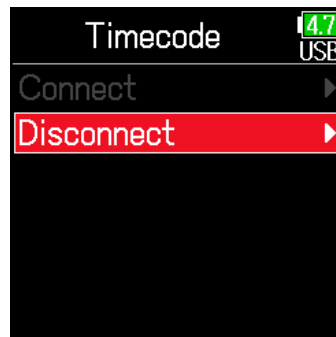

**HINT**

After disconnecting, to connect to an UltraSync BLUE, select Menu > System > Bluetooth > Timecode > Connect.

## ■ Connecting to a different UltraSync BLUE

To receive timecode from an UltraSync BLUE other than the one connected to the **F6**, the pairing with the current UltraSync BLUE must be removed, and pairing with the other UltraSync BLUE must be conducted.

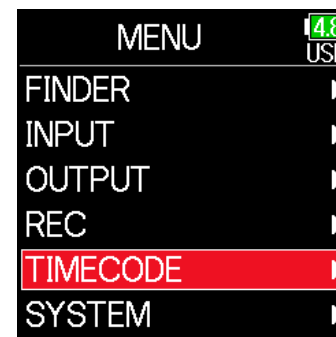

1. Press .

2. Use and to select TIMECODE, and press .

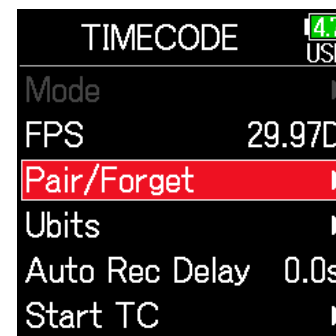

3. Use and to select Pair/Forget and press .



4. Use  and  to select Forget, and press .

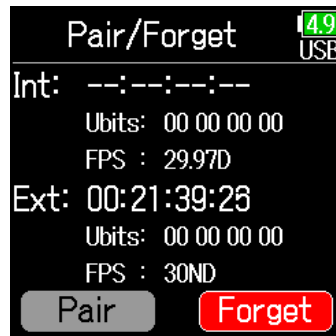

#### HINT

- See the UltraSync BLUE manual for the procedures to select connected devices.
- Use the **F6** and the UltraSync BLUE as close together as possible to make communication more reliable.
- Even if communication with the UltraSync BLUE is interrupted, timecode generated by the **F6** will be added to recording files.

5. Use  and  to select Pair, and press .

Searching for the connected device will begin and "Searching" will appear on the display.

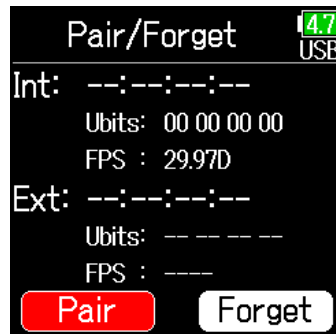

#### HINT

- Searching can be canceled by pressing any button.
- After canceling searching, it can be restarted by selecting Menu > Timecode > Pair/Forget > Pair again.

6. Select as the connected device on the other UltraSync BLUE.

When pairing completes, "Connected" will appear on the **F6** display.

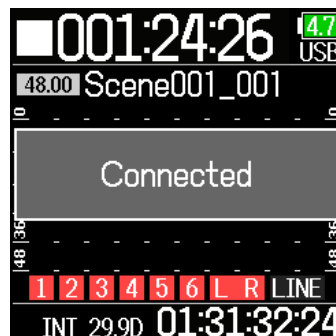









# Other settings

## Setting the level meter peak hold time

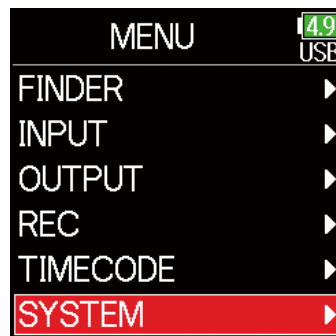

1. Press .

2. Use  and  to select SYSTEM, and press .

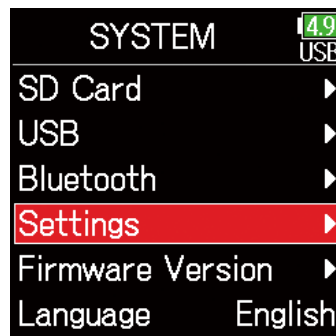

3. Use  and  to select Settings, and press .



4. Use  and  to select Display, and press .

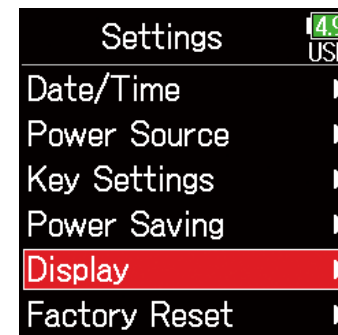

5. Use  and  to select Peak Hold Time, and press .

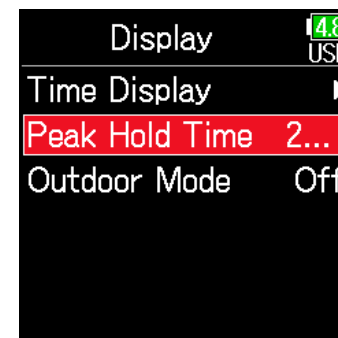

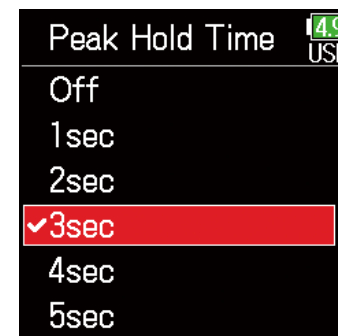

6. Use  and  to adjust the peak hold time, and press .







# Setting the LED brightness

The brightness of the LEDs on the front of the **F6** can be set.

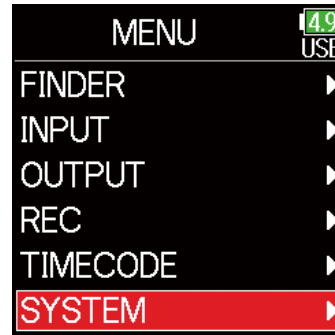

1. Press .

2. Use  and  to select SYSTEM, and press .



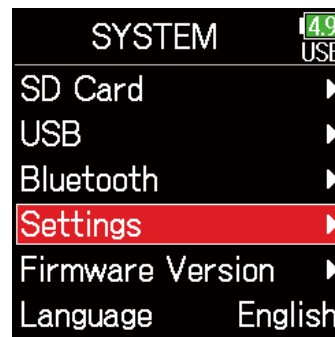

3. Use  and  to select Settings, and press .



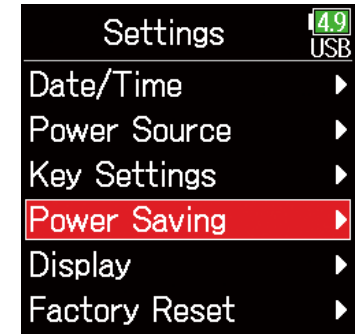

4. Use  and  to select Power Saving, and press .

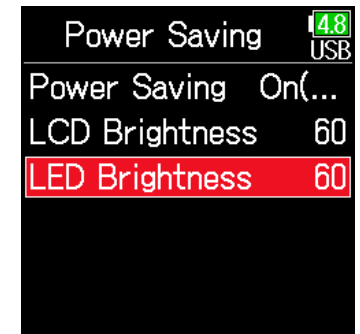

5. Use  and  to select LED Brightness, and press .



6. Use  and  to adjust the brightness, and press .

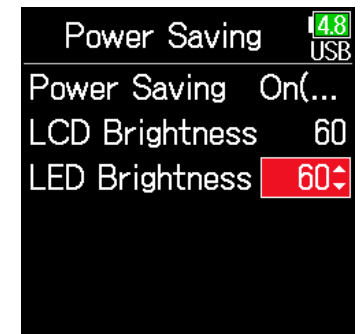



**HINT**

This can be set from 5 to 100.



# Making display settings

Settings related to the display can be made.

1. Press .

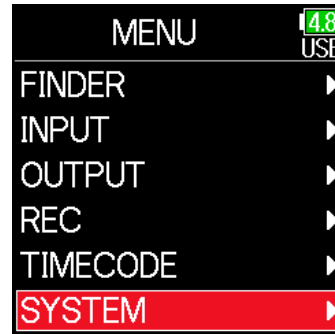

2. Use  and  to select SYSTEM, and press .



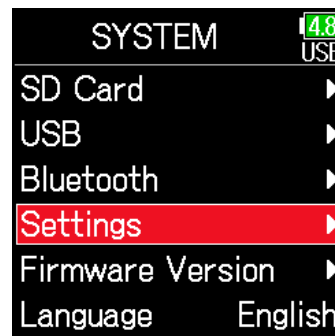



3. Use  and  to select Settings, and press .

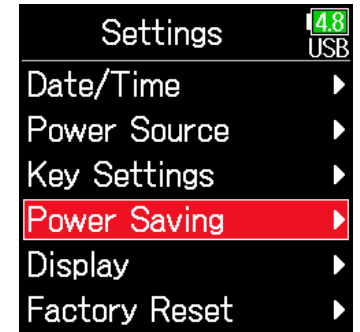

## Setting the display brightness

4. Use  and  to select Power Saving, and press .



5. Use  and  to select LCD Brightness, and press .

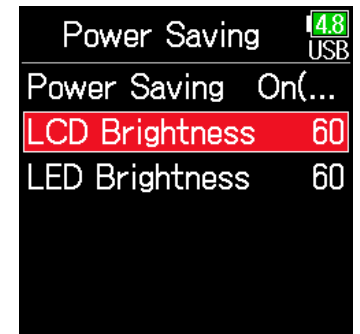

▶ Continue to one of the following procedures.

Setting the display brightness ..... P. 164

Changing the display backlight setting ..... P. 165

Making the display easier to read under bright light ..... P. 166

6. Use and to adjust the brightness, and press .

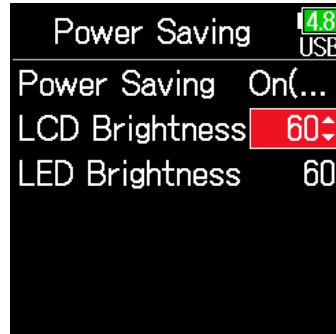

**HINT**

This can be set from 5 to 100.

**■ Changing the display backlight setting**

The display backlight can be set to dim when 30 seconds pass without use.

4. Use and to select Power Saving, and press .

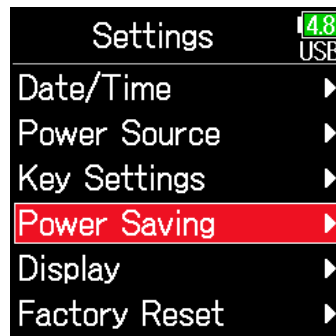

5. Use and to select Power Saving, and press .



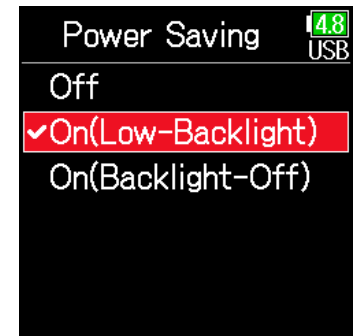

6. Use and to select the setting, and press .







Setting	Explanation
Off	The backlight brightness does not change even after time passes without use.
On (Low-Backlight)	The backlight dims after time without use.
On (Backlight-Off)	The backlight turns off after time without use.

## ■ Making the display easier to read under bright light

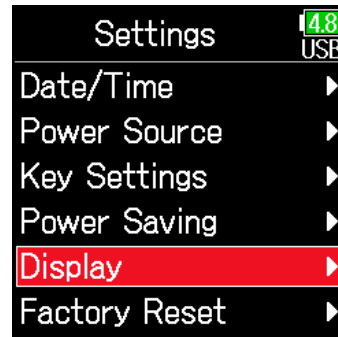
The display can be set to be easier to read in bright environments including in sunlight.

4. Use  and  to select Display, and press .



5. Use  and  to select Outdoor Mode, and press .

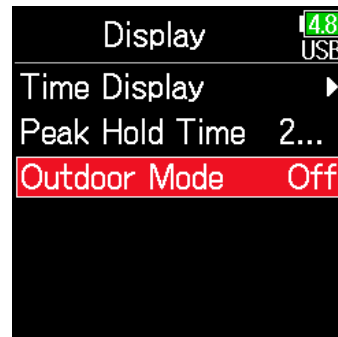

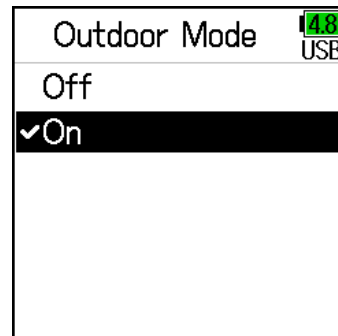

6. Use  and  to select On, and press .





# Setting how marks are added manually

How marks are added when  is pressed while recording or playing back a WAV format file can be set.

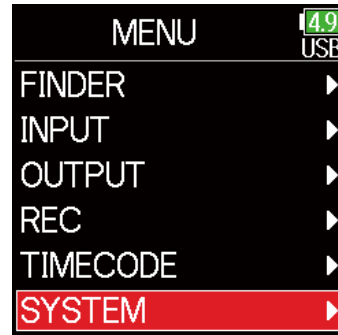

1. Press .

2. Use  and  to select SYSTEM, and press .



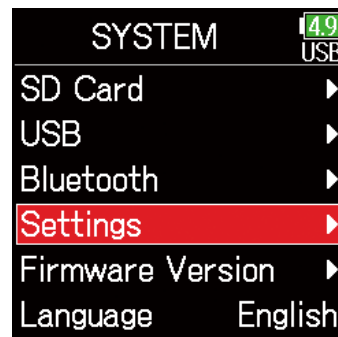

3. Use  and  to select Settings, and press .

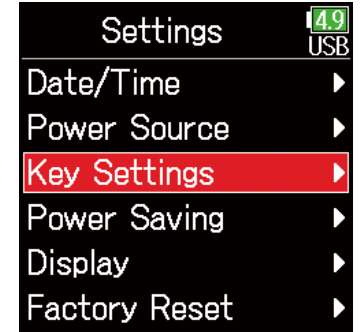

4. Use  and  to select Key Settings, and press .



5. Use  and  to select PLAY Key Option, and press .

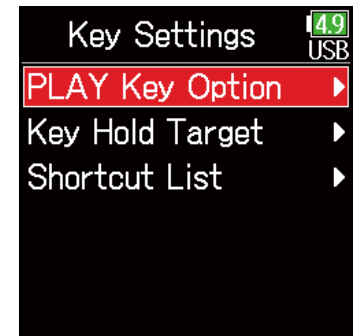



▶ Continue to one of the following procedures.



Setting how marks are added when recording..... P. 168

Setting how marks are added when playing ..... P. 168

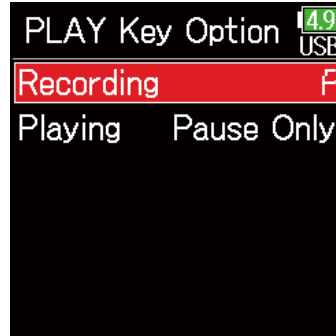

## ■ Setting how marks are added when recording

6. Use  and  to select Recording, and press .





7. Use  and  to select how marks are added, and press .





Setting	Explanation
Pause Only	Pressing  will pause without adding a mark.
Pause & Mark	Pressing  will pause and add a mark.
Mark Only	Pressing  will add a mark without pausing.

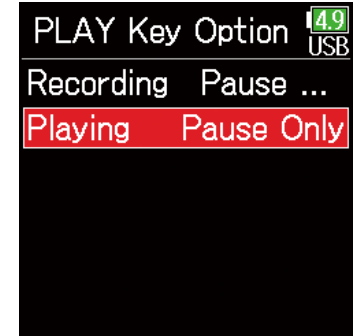

## ■ Setting how marks are added when playing

6. Use  and  to select Playing, and press .

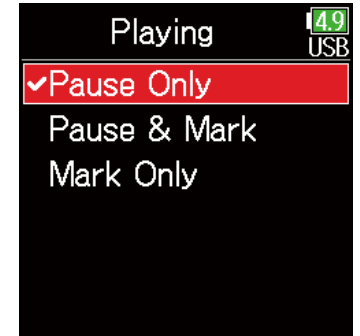

7. Use  and  to select how marks are added, and press .





Setting	Explanation
Pause Only	Pressing  will pause without adding a mark.
Pause & Mark	Pressing  will pause and add a mark.
Mark Only	Pressing  will add a mark without pausing.



# Setting the buttons held

Use the hold function to prevent misoperation during recording. Press and hold  to enable and disable the hold function. Follow these instructions to set which keys are disabled by the hold function.

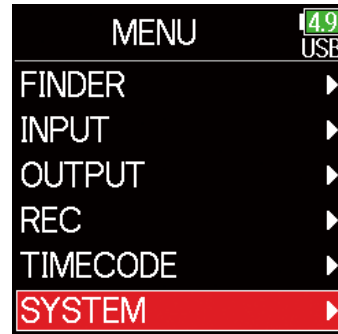

1. Press .

2. Use  and  to select SYSTEM, and press .



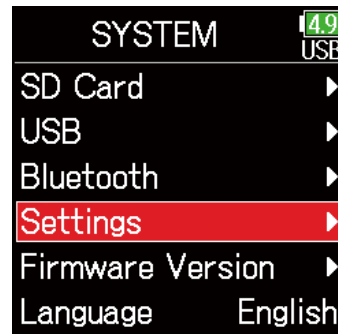

3. Use  and  to select Settings, and press .



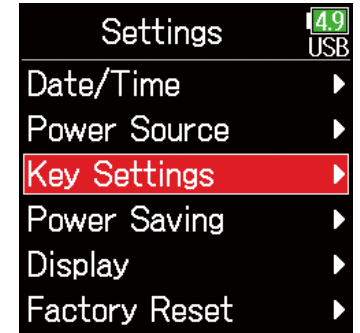

4. Use  and  to select Key Settings, and press .

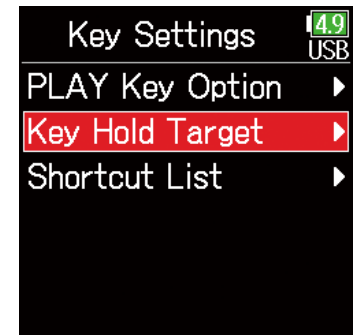

5. Use  and  to select Key Hold Target, and press .



6. Use  and  to select the keys to be held, and press .



## HINT

Track Knobs 1–6, MENU, ENTER, UP, DOWN, PLAY, REC, STOP, HP Volume Push and HP Volume Turn can be selected.

## 7. Press .

## HINT



- Even when hold is on for HP Volume Push, pressing and holding  will turn the hold function off.
- Operation using the **FRC-8** and F6 Control is possible even when the hold function is on.

# Other functions



## Checking SD card information

The size and open space of SD cards can be checked.

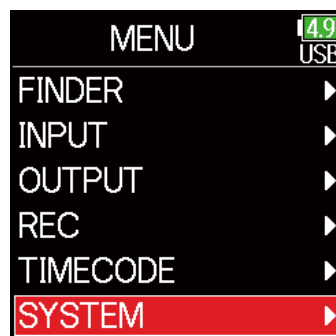

1. Press .

2. Use  and  to select SYSTEM, and press .

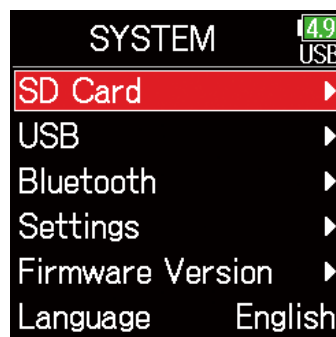

3. Use  and  to select SD Card, and press .



4. Use  and  to select Information, and press .

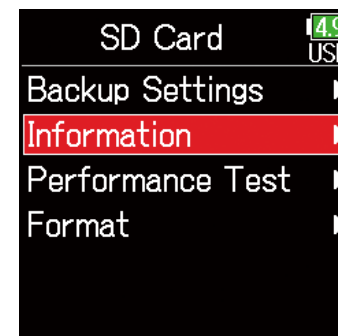

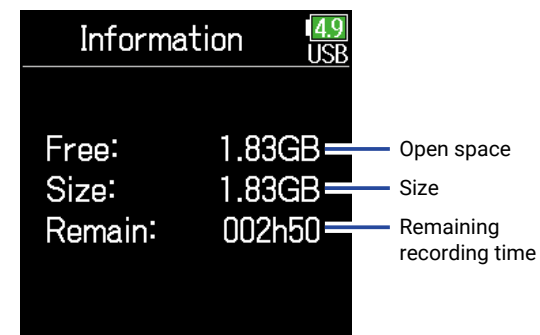

### ■ SD card information







# Testing SD card performance

SD cards can be tested to confirm whether they can be used with the **F6**. A basic test can be done quickly, while a full test examines the entire SD card.

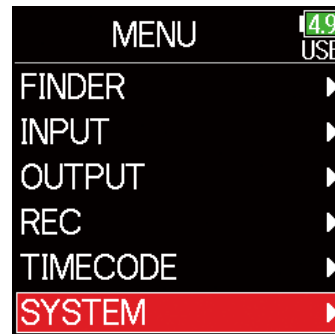

1. Press .

2. Use  and  to select SYSTEM, and press .

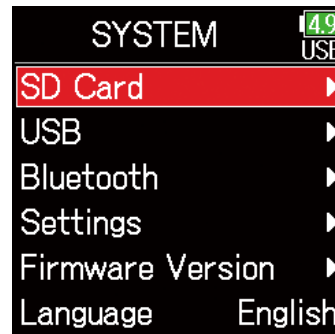

3. Use  and  to select SD Card, and press .



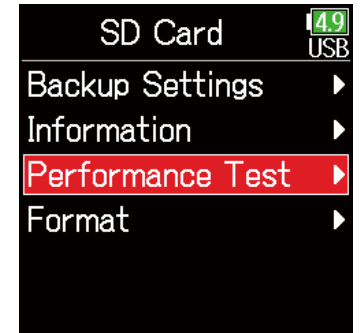

4. Use  and  to select Performance Test, and press .



▶ Continue to one of the following procedures.

Conducting a quick test .....	P. 173
Conducting a full test .....	P. 174

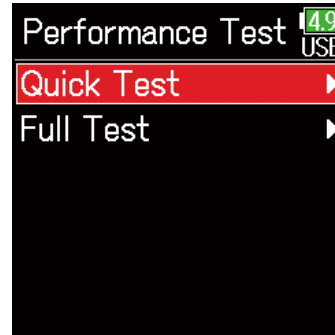

## ■ Conducting a quick test

5. Use  and  to select Quick Test, and press .



### NOTE

Even if a performance test result is "OK", there is no guarantee that writing errors will not occur. This information is just to provide guidance.

6. Use  and  to select Execute, and press .
- The card performance test will start.  
The test should take about 30 seconds.

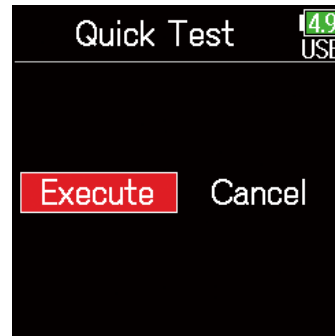

### The test completes.

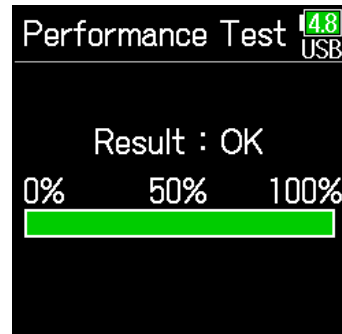

The result of the evaluation will be shown.



### HINT



Press  to stop the test.

## ■ Conducting a full test

5. Use  and  to select Full Test, and press .

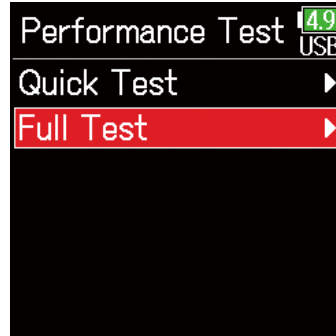
The amount of time required for the full test will be shown.



6. Use  and  to select Execute, and press .



### The test completes.

The result of the evaluation will be shown. If the access rate MAX reaches 100%, the card will fail (NG).

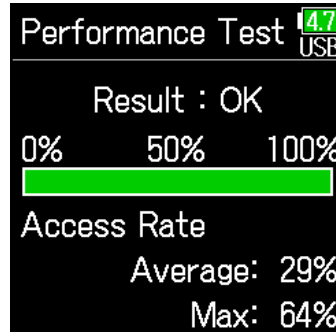

### HINT

Press  to stop the test.



### NOTE

Even if a performance test result is "OK", there is no guarantee that writing errors will not occur. This information is just to provide guidance.



# Formatting SD cards

Formatting SD cards for use with the **F6**.

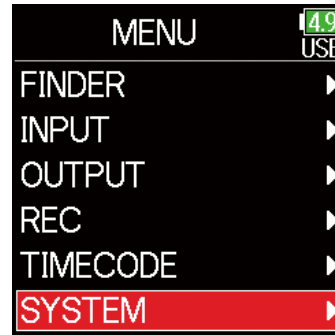

1. Press .

2. Use  and  to select SYSTEM, and press .



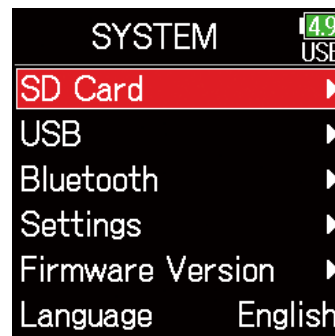

3. Use  and  to select SD Card, and press .

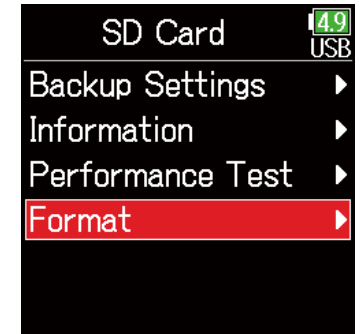

4. Use  and  to select Format, and press .



5. Use  and  to select Execute, and press .

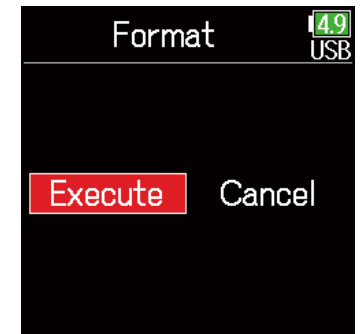



## NOTE

- Before using SD cards that have just been purchased or that have been formatted on a computer, they must be formatted by the **F6**.
- Be aware that all data previously saved on the SD card will be deleted when it is formatted.

# Checking the F6 Shortcut List

The **F6** has a shortcut feature that allows quick access to various functions. See the "List of shortcuts" (→ P. 189) to check the shortcut functions.

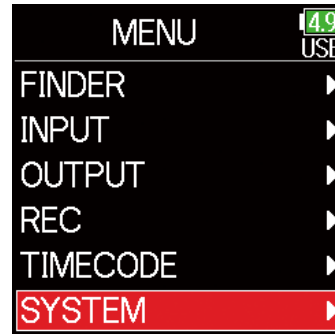

1. Press .

2. Use  and  to select SYSTEM, and press .



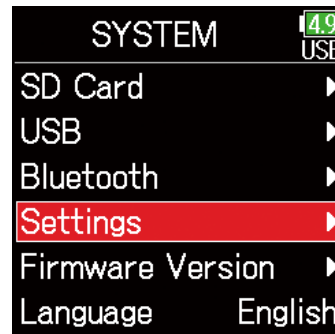

3. Use  and  to select Settings, and press .

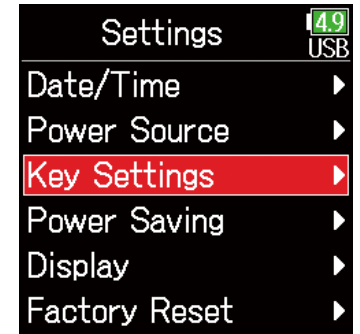

4. Use  and  to select Key Settings, and press .



5. Use  and  to select Shortcut List, and press .

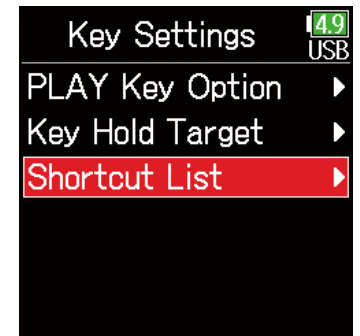









# Backing up and loading F6 settings

F6 settings can be backed up to and loaded from SD cards.

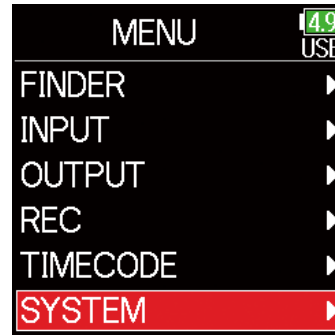
1. Press .

2. Use  and  to select SYSTEM, and press .



3. Use  and  to select SD Card, and press .

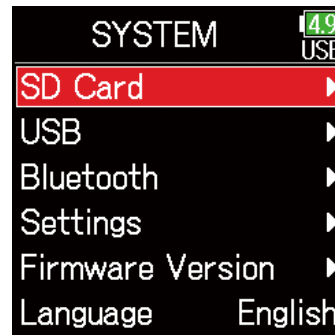

4. Use  and  to select Backup Settings, and press .

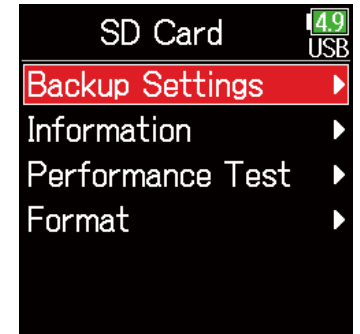



▶ Continue to one of the following procedures.

Backing up .....	P. 178
Loading .....	P. 178

## ■ Backing up

This saves a backup file to the "F6\_SETTINGS" folder in the root directory of the SD card.

5. Use  and  to select Backup, and press .

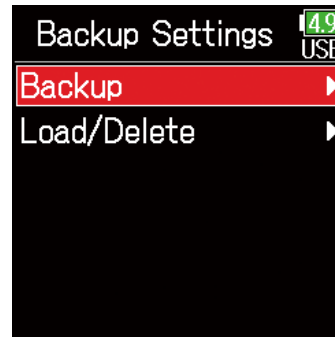

6. Edit the name of the file saved.

See "Character input screen" (→ P. 11) for how to input characters.

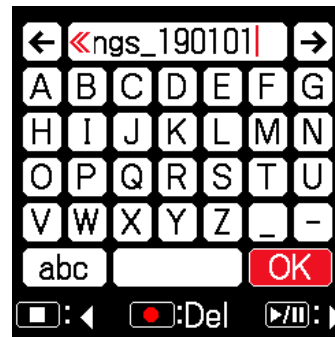



### HINT



The extension of the saved backup file is ".ZSF".

## ■ Loading

Backup files that are saved in the "F6\_SETTINGS" folder in the root directory of the SD card can be loaded.

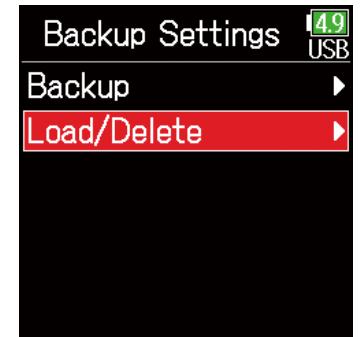
5. Use  and  to select Load/Delete, and press .



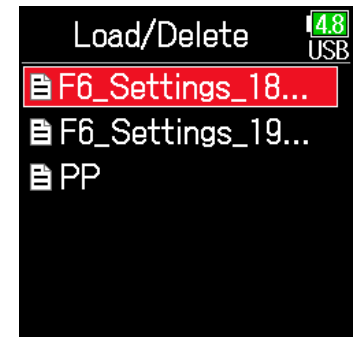

6. Use  and  to select the file to load, and press .



### HINT

- Press and hold  to delete a file.
- Deleting a file will completely erase its data.

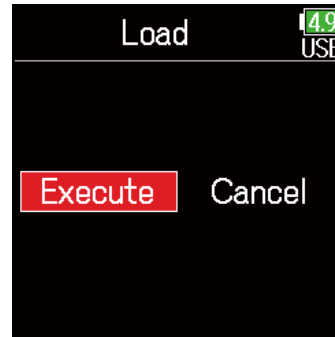

7. Use  and  to select Execute, and press .







# Restoring default setting values

The factory default settings can be restored.

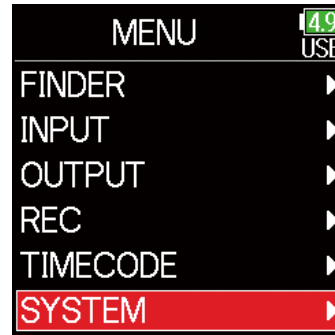

1. Press .

2. Use  and  to select SYSTEM, and press .



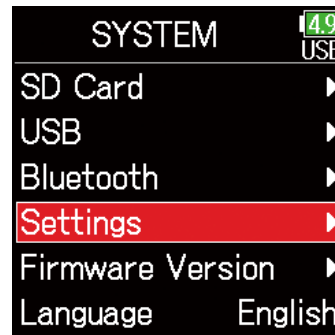

3. Use  and  to select Settings, and press .

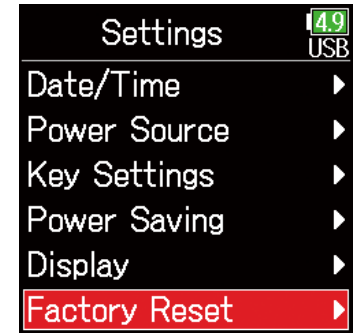

4. Use  and  to select Factory Reset, and press .



5. Use  and  to select Execute, and press .



The settings will be reset and the power will automatically turn off.







# Checking the firmware version

Firmware versions can be checked.

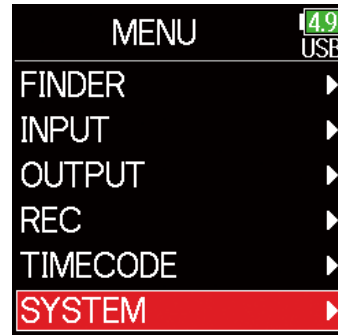
1. Press .

2. Use  and  to select SYSTEM, and press .



3. Use  and  to select Firmware Version, and press .

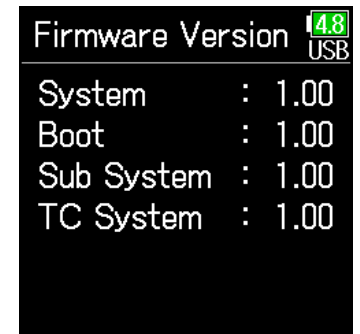
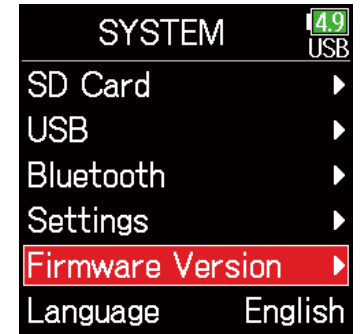

# Updating the firmware

The **F6** firmware can be updated to the latest versions.

The latest update file can be downloaded from the ZOOM website ([www.zoom.co.jp](http://www.zoom.co.jp)).



1. Install new batteries in the **F6** or connect the dedicated AC adapter to the USB connector.

## NOTE

Upgrading is not possible if the remaining battery power is low. In this case, replace the batteries with new ones or use the dedicated adapter.

2. Copy the update file to the root directory on an SD card.

3. Load the SD card into the card slot, and turn the power on while pressing .

4. Use  and  to select Update, and press .

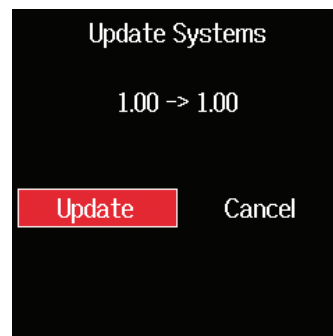

## NOTE

Do not turn the power off or remove the SD card during the update. Doing so could cause the **F6** to become unstartable.

5. After the update completes, turn the power off.

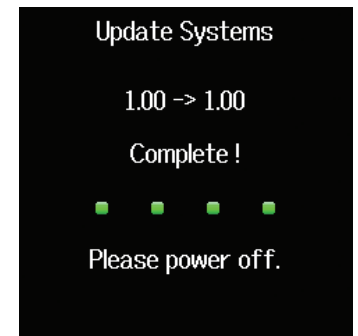

## Troubleshooting

If you think that the **F6** is operating strangely, check the following items first.

### ■ Recording/playback trouble

#### ◆ There is no sound or output is very quiet

- Check the connections to the monitoring system and its volume setting.
- Confirm that the volume of the **F6** is not too low. ( → P. 33)

#### ◆ Sound from connected equipment or inputs cannot be heard or is very quiet

- Check the input level settings. ( → P. 25)
- If a CD player or other device is connected to an input jack, raise the output level of that device.
- Check the input signal monitoring settings. ( → P. 76)
- Check the phantom power and plug-in power settings. ( → P. 78, P. 92)
- Check the headphone and line output routing settings. ( → P. 106, P. 109, P. 110)

#### ◆ Recording is not possible

- Confirm that the status indicators are lit red.
- Confirm that the SD card has open space. ( → P. 171)
- Confirm that an SD card is loaded properly in a card slot.
- If “Card Protected!” appears on the display, the SD card write-protection is enabled. Slide the lock switch on the SD card to disable write-protection.

#### ◆ The recorded sound cannot be heard or is very quiet

- Confirm that the volume levels of the tracks are not too low. ( → P. 52)
- Confirm that the status indicators are lit green during playback.

### ■ Other trouble

#### ◆ Computer does not recognize it even though it is connected to the USB port.

- Confirm that the operating system is compatible. ( → P. 136)
- The operation mode must be set on the **F6** to allow the computer to recognize the **F6**. ( → P. 138)

## ◆ Battery operation time is short

Making the following settings could increase the battery operation time.

- Set the power supply used correctly. ( → P. 20)
- Turn unnecessary tracks off. ( → P. 24)
- Disconnect unneeded devices that are plugged into the HEADPHONE, LINE OUT or TIMECODE IN/OUT jacks, for example.
- Set the phantom power voltage to 24V. ( → P. 93)
- Disable phantom power during playback. ( → P. 93)
- Turn timecode off if not using it. ( → P. 125)
- Reduce the LED brightness.( → P. 162)
- Reduce the LCD brightness.( → P. 164)
- Set the display to dim when not used for some time. ( → P. 165)
- Reduce the sampling rate used to record files. ( → P. 27).
- Due to their characteristics, using nickel metal hydride batteries (especially high-capacity ones) or lithium batteries should enable longer use than alkaline batteries when power consumption is high.



# Metadata list

## ■ Metadata contained in WAV file BEXT chunks

Tag	Explanation	Remarks
zSPEED=	Frame rate	MENU > TIMECODE > FPS
zTAKE=	Take number	
zUBITS=	Ubits	MENU > TIMECODE > Ubits
zSCENE=	Scene Name	MENU > REC > Metadata > Scene Name > Mode MENU > REC > Metadata > Scene Name > User Name MENU > FINDER > Option > Metadata Edit > Scene > Scene/Take MENU > FINDER > Option > Rename
zTAPE=	Name of recording destination folder	MENU > FINDER (recording destination folder name) MENU > FINDER > Option > Metadata Edit > Tape Name
zCIRCLED=	Circled take	MENU > FINDER > Option > Metadata Edit > Circle
zTRK1=	Left track name	Track names are written as follows. TRK1=TrL, TRK2=TrR, TRK3=Tr1, TRK4=Tr2 ... TRK8=Tr6
zTRK2=	Right track name	
zTRK3=	Track 1 name	
zTRK4=	Track 2 name	
zTRK5=	Track 3 name	
zTRK6=	Track 4 name	
zTRK7=	Track 5 name	
zTRK8=	Track 6 name	
zNOTE=	Take note	MENU > Metadata > Note MENU > FINDER > Option > Metadata Edit > Note

## ■ Metadata contained in WAV file iXML chunks

iXML master tag	iXML sub tag	Written	Read	Remarks
<PROJECT>		○	○	MENU > FINDER (folder name at top SD card level) MENU > FINDER > Option > Metadata Edit > Project Name
<SCENE>		○	○	MENU > REC > Metadata > Scene Name > Mode MENU > REC > Metadata > Scene Name > User Name MENU > FINDER > Option > Metadata Edit > Scene > Scene/Take MENU > FINDER > Option > Rename
<TAKE>		○	○	MENU > FINDER > Option > Metadata Edit > Take MENU > FINDER > Option > Rename
<TAPE>		○	○	MENU > FINDER (recording destination folder name) MENU > FINDER > Option > Metadata Edit > Folder (Tape) Name
<CIRCLED>		○	○	MENU > FINDER > Option > Metadata Edit > Circle
<WILD TRACK>		×	×	
<FALSE START>		×	×	
<NO GOOD>		×	×	
<FILE_UID>		○	×	
<UBITS>		○	×	MENU > TIMECODE > Timecode > Ubits
<NOTE>		○	○	MENU > REC > Metadata > Note MENU > FINDER > Option > Metadata Edit > Note
<BEXT>		×	×	
<USER>		×	×	

iXML master tag	iXML sub tag	Written	Read	Remarks
<SPEED>				
<SPEED>	<NOTE>	○	×	
<SPEED>	<MASTER_SPEED>	○	○	MENU > TIMECODE > FPS
<SPEED>	<CURRENT_SPEED>	○	×	MENU > TIMECODE > FPS
<SPEED>	<TIMECODE_RATE>	○	×	MENU > TIMECODE > FPS
<SPEED>	<TIMECODE_FLAG>	○	×	MENU > TIMECODE > FPS
<SPEED>	<FILE_SAMPLE_RATE>	○	×	MENU > REC > Sample Rate
<SPEED>	<AUDIO_BIT_DEPTH>	○	×	MENU > REC > Mode
<SPEED>	<DIGITIZER_SAMPLE_RATE>	○	×	MENU > REC > Sample Rate
<SPEED>	<TIMESTAMP_SAMPLES_SINCE_MIDNIGHT_HI>	○	×	
<SPEED>	<TIMESTAMP_SAMPLES_SINCE_MIDNIGHT_LO>	○	×	
<SPEED>	<TIMESTAMP_SAMPLE_RATE>	○	×	MENU > REC > Sample Rate

iXML master tag	iXML sub tag	Written	Read	Remarks
<SYNC_POINT_LIST>				
<SYNC_POINT>	<SYNC_POINT_TYPE>	×	×	
<SYNC_POINT>	<SYNC_POINT_FUNCTION>	×	×	
<SYNC_POINT>	<SYNC_POINT_COMMENT>	×	×	
<SYNC_POINT>	<SYNC_POINT_LOW>	×	×	
<SYNC_POINT>	<SYNC_POINT_HIGH>	×	×	
<SYNC_POINT>	<SYNC_POINT_EVENT_DURATION>	×	×	

iXML master tag	iXML sub tag	Written	Read	Remarks
<HISTORY>				
<HISTORY>	<ORIGINAL_FILENAME>	○	×	
<HISTORY>	<PARENT_FILENAME>	×	×	
<HISTORY>	<PARENT_UID>	×	×	

iXML master tag	iXML sub tag	Written	Read	Remarks
<FILE_SET>				
<FILE_SET>	<TOTAL_FILES>	○	×	
<FILE_SET>	<FAMILY_UID>	○	×	
<FILE_SET>	<FAMILY_NAME>	×	×	
<FILE_SET>	<FILE_SET_START_TIME_HI>	×	×	
<FILE_SET>	<FILE_SET_START_TIME_LO>	×	×	
<FILE_SET>	<FILE_SET_INDEX>	○	×	

iXML master tag	iXML sub tag	Written	Read	Remarks
<TRACK_LIST>				
<TRACK_LIST>	<TRACK_COUNT>	○	×	
<TRACK>	<CHANNEL_INDEX>	○	×	
<TRACK>	<INTERLEAVE_INDEX>	○	×	
<TRACK>	<NAME>	○	○	MENU > REC > Metadata > Track Name MENU > FINDER > Option > Metadata Edit > Track Name
<TRACK>	<FUNCTION>	×	×	













○ = YES × = NO

## ■ Metadata and ID3 fields contained in MP3 files





Metadata	ID3 field	Format
Timecode	Artist Name	TC=[HH:MM:SS:FF]
Scene name, take number	Track Title	SC=[scene name] TK=[take number]
Frame rate, file length (time)	Album Title	FR=[frame rate] D=[file length (time)]

# List of shortcuts

## ■ Home Screen

Operation from <b>F6</b>	Operation from <b>FRC-8</b>	Explanation
Press and hold 	Press and hold MENU	Show the name that will be given to the next take recorded. Example: Scene001_002
 + 	MENU + ENCODER press	Advance the scene number by 1 (when the Home Screen is open).
 + 	MENU + FF	The number given to the next recorded take can be increased or decreased by one when the Home Screen is open.
 + 	MENU + REW	Move the previously recorded take to the FALSE TAKE folder (when the Home Screen is open).
 + 	ENCODER press + FF	Open L/R track fader and line output level setting screen.
 + 	ENCODER press + REW	Click the level meter clipping indicators.
Press and hold 	Press and hold FF	Circle the currently selected take.

## ■ Input link, trim link and routing screens

Operation from <b>F6</b>	Operation from <b>FRC-8</b>	Explanation
 + 	-	Move the cursor up.
 + 	-	Move the cursor down.

## ■ All screens

Operation from <b>F6</b>	Operation from <b>FRC-8</b>	Explanation
Press and hold 	-	Disable controls set with "Key Hold".

# Block diagrams

## Input and output signal flow (Linear and Dual modes)

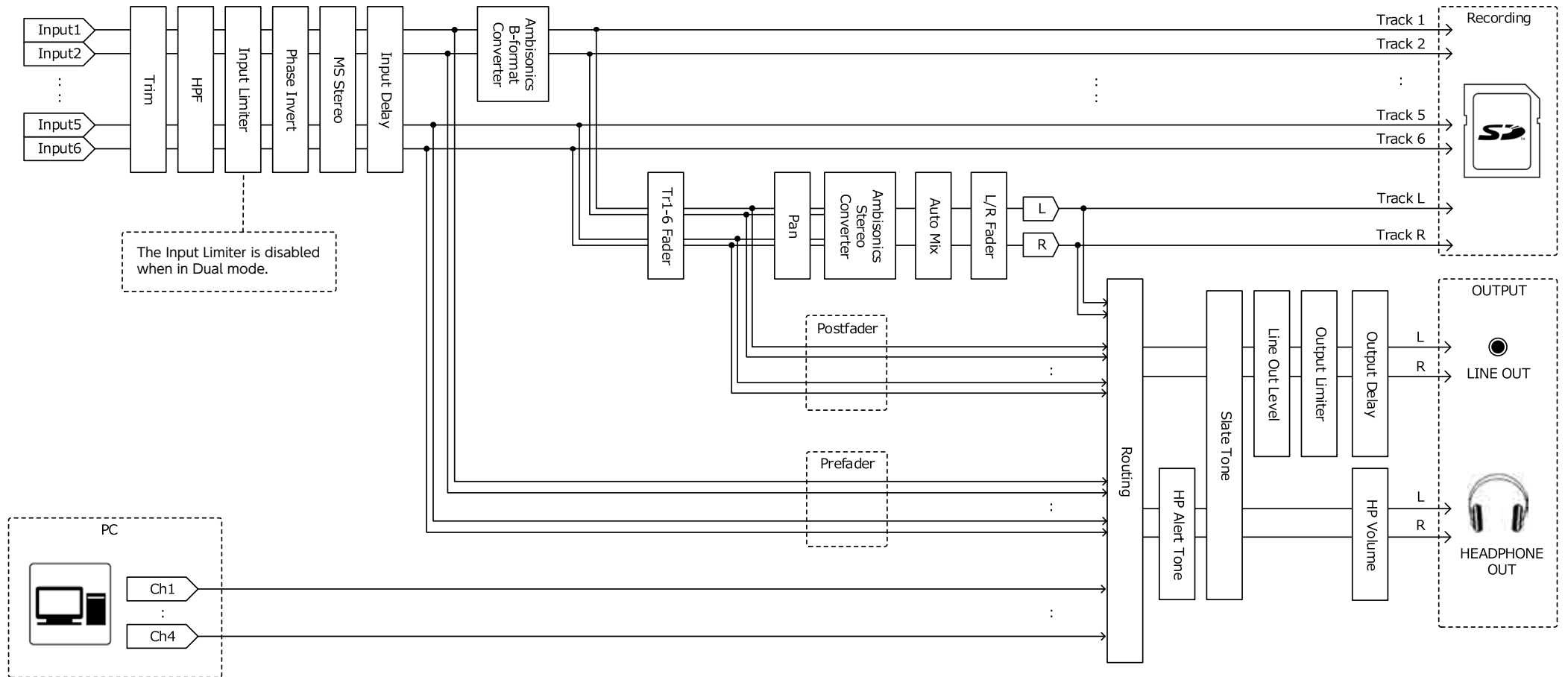

## Input and output signal flow (Float mode)

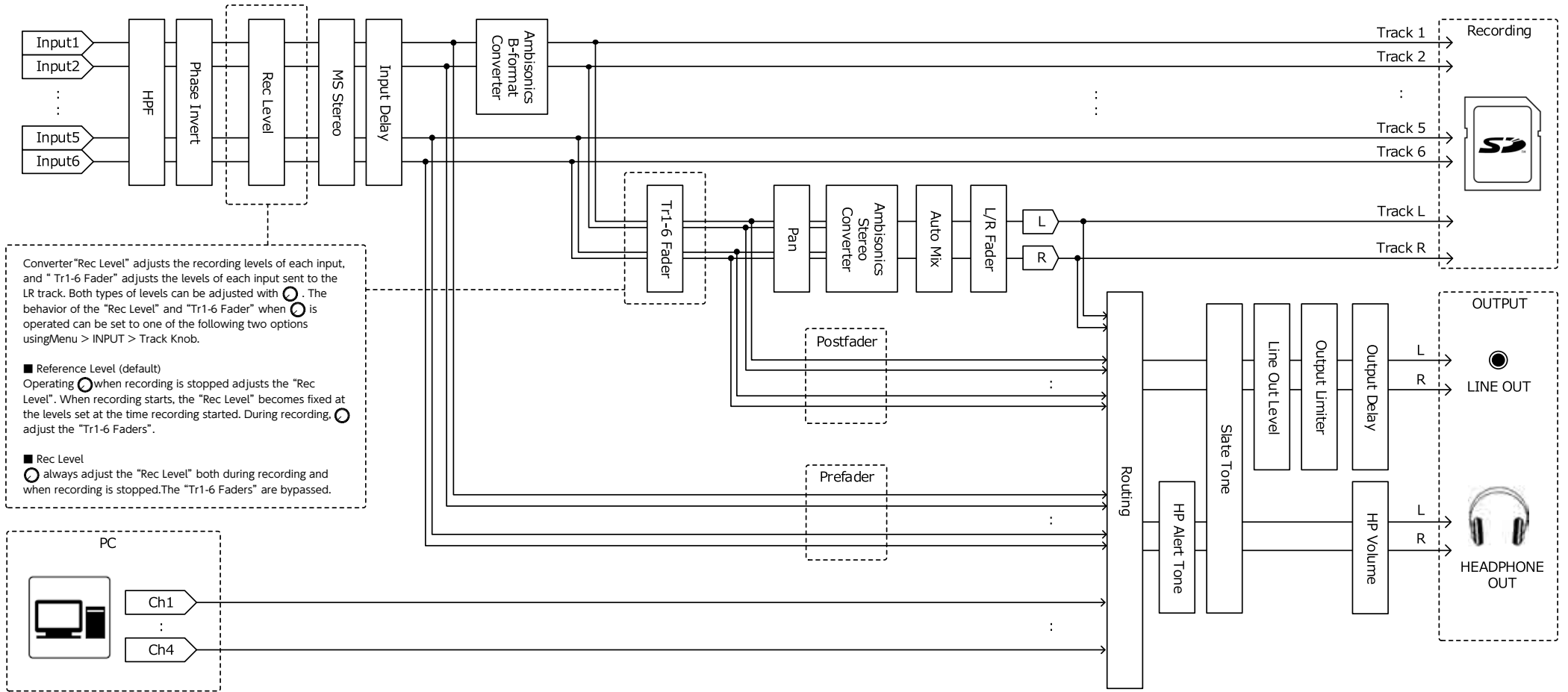

## Input and output signal flow (Audio Interface Stereo Mix)

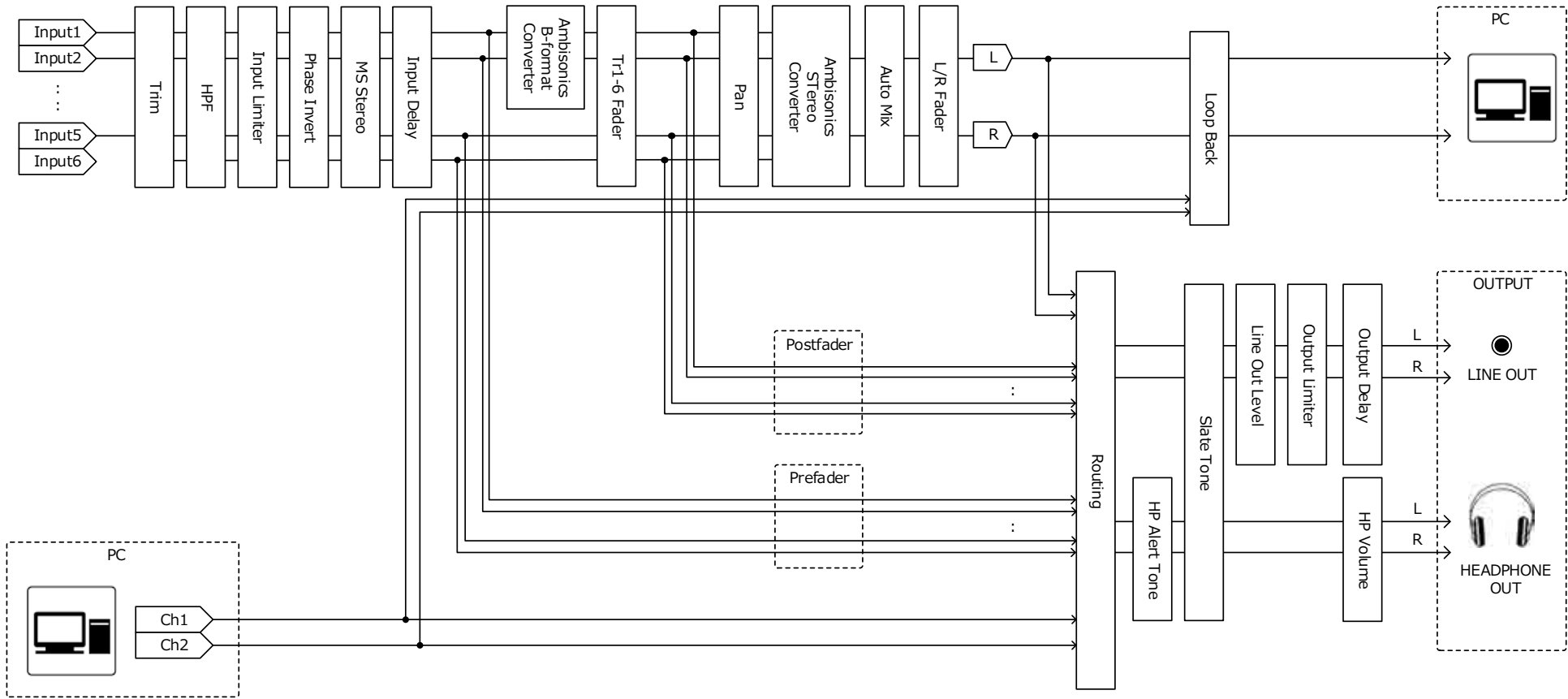



## Input and output signal flow (Audio Interface Multi Track)

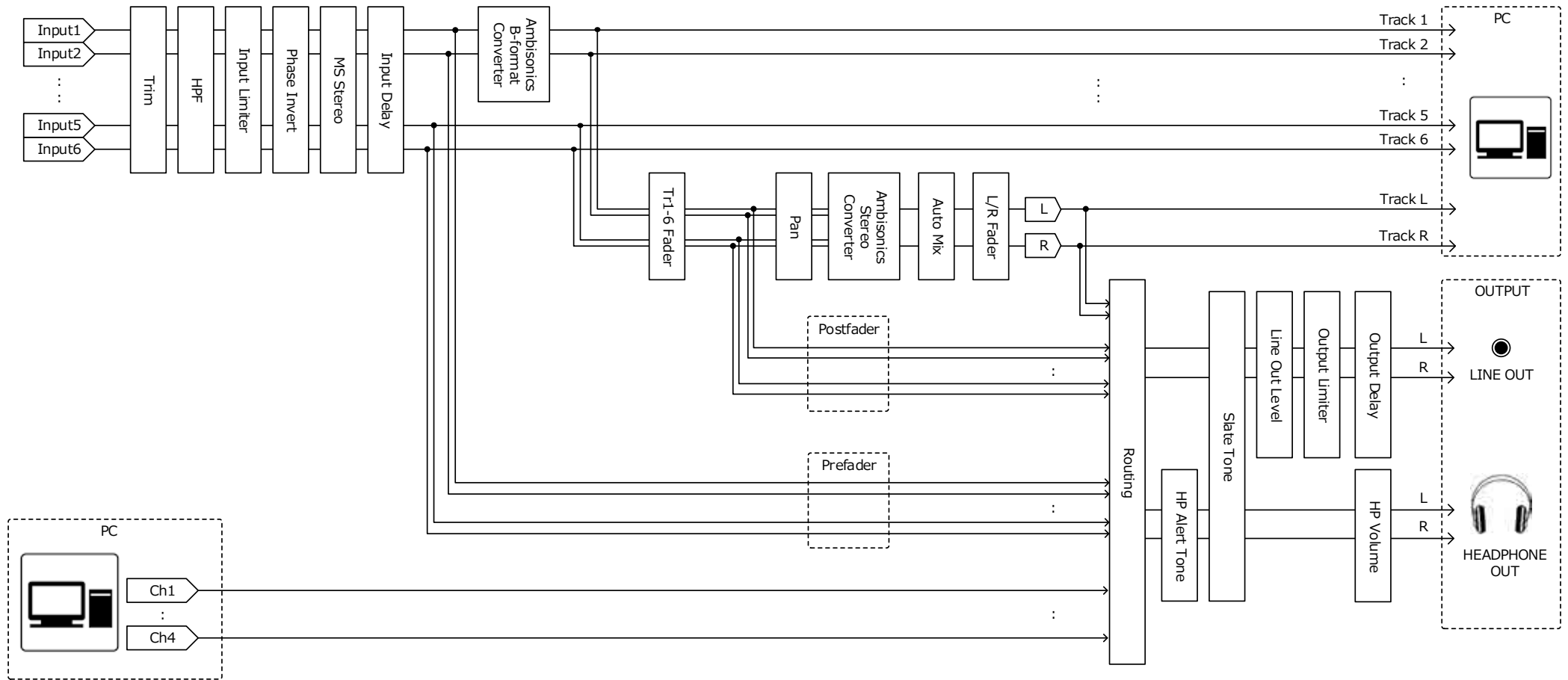

# Detailed block diagram (Linear & Dual modes)

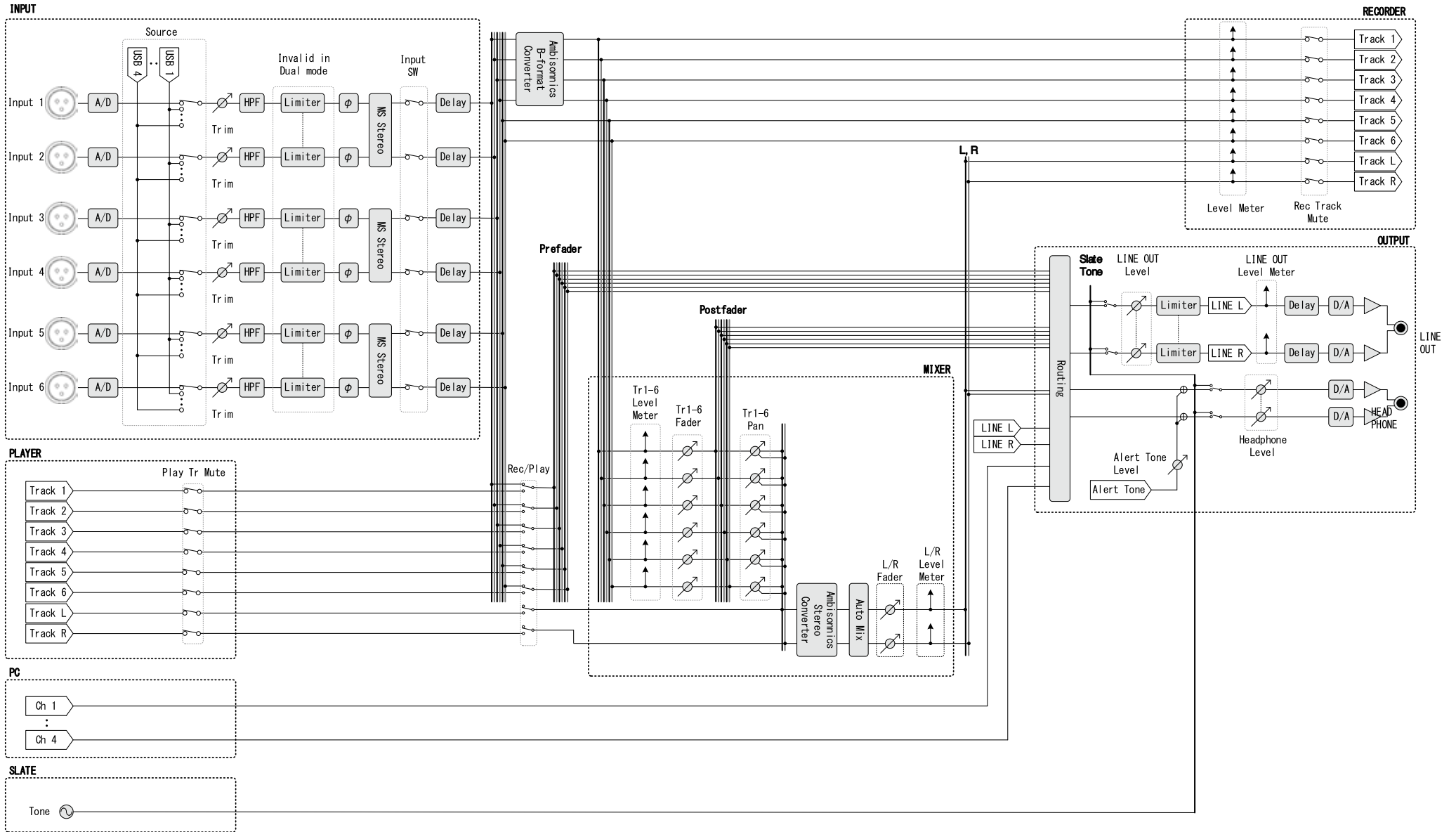

# Detailed block diagram (Float mode)

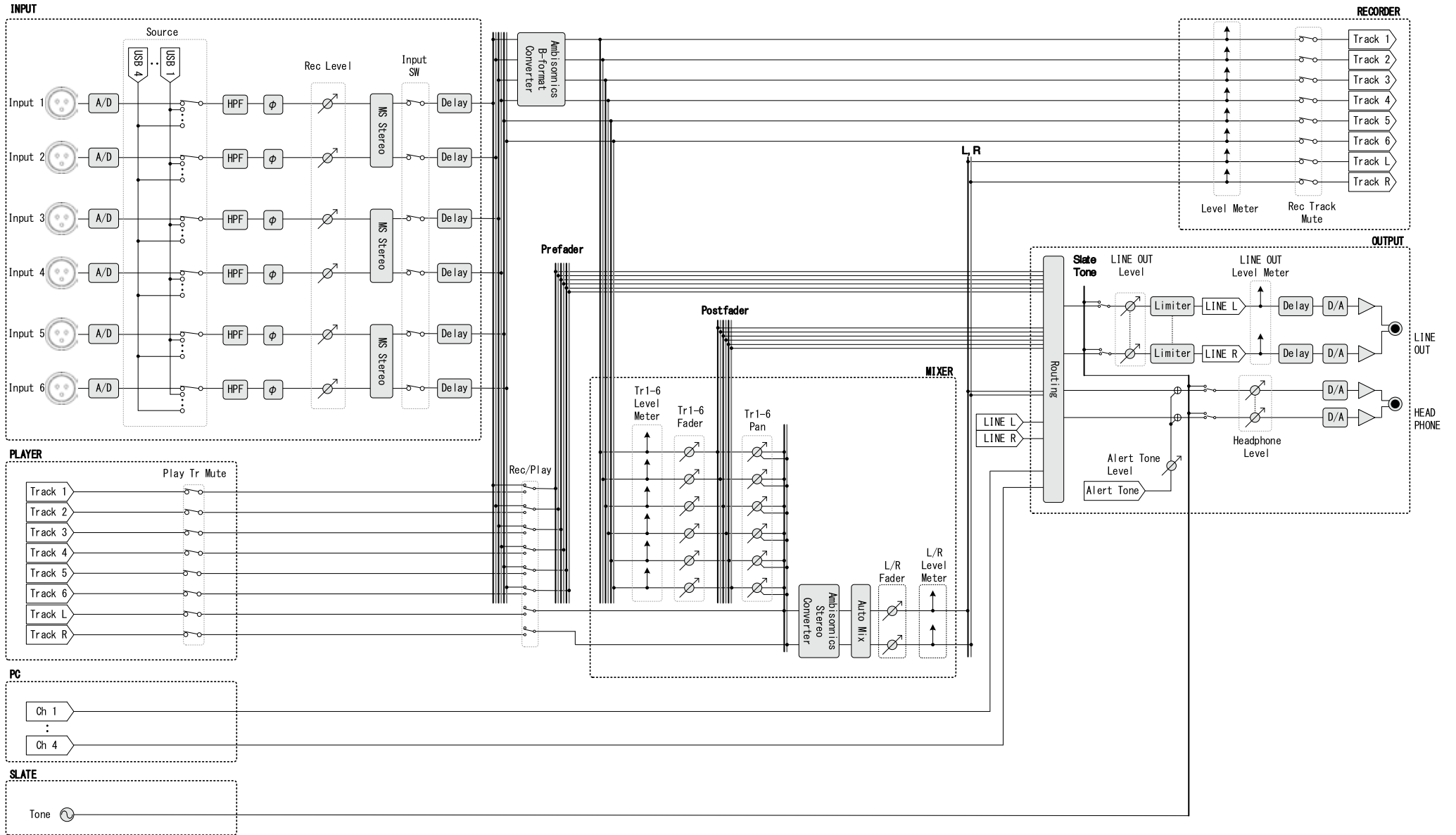

## Detailed block diagram (Routing)

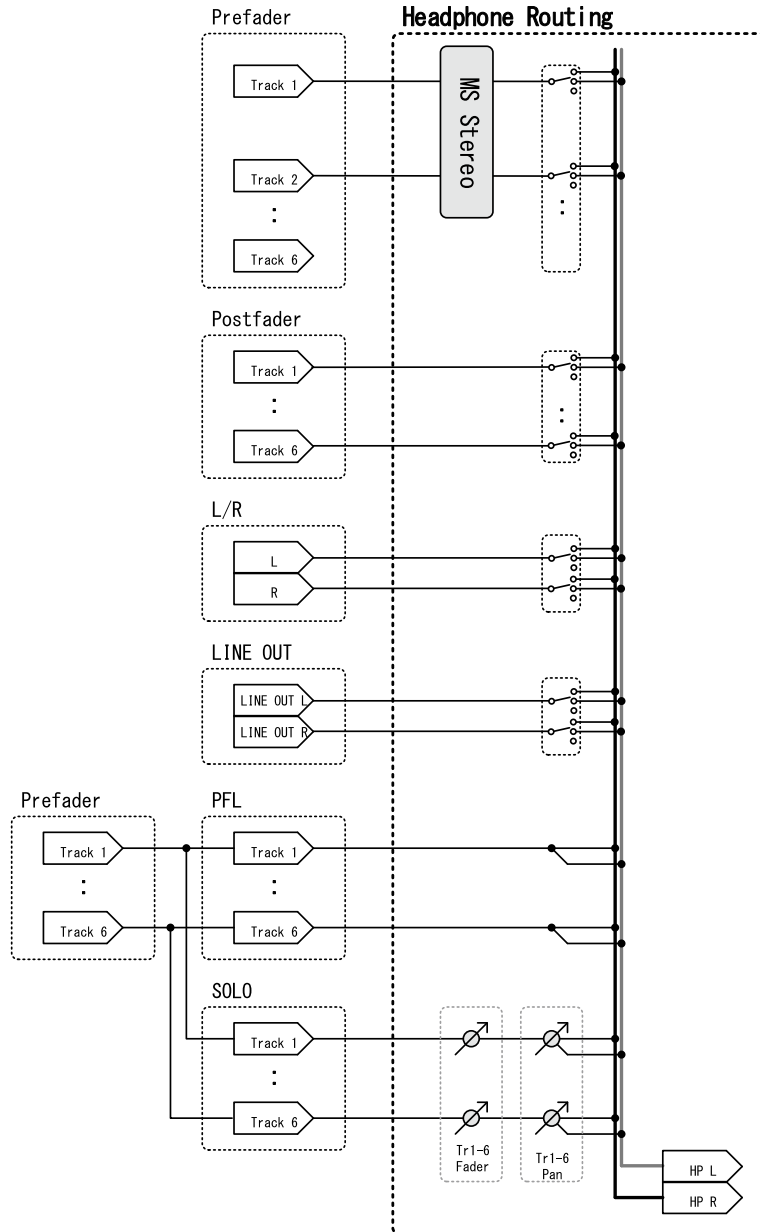
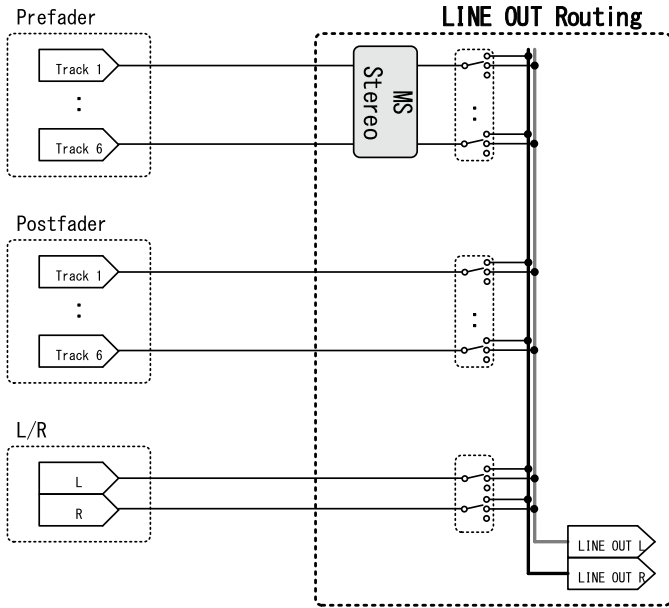

# Specifications

Recording media		SD cards, SDHC cards, SDXC cards (that conform to standards)
Inputs	Inputs 1–6	Connectors XLR jack (pin 2 hot)
	Input (mic)	Input gain +12 dB – +75 dB
		Input impedance 3 k $\Omega$
		Maximum input level +4 dBu
		Input (line)
		Input impedance 5 k $\Omega$
		Maximum input level +24 dBu
	Phantom power +24/+48V 10mA maximum for each channel	
Equivalent input noise -127 dBu or less (A-weighted, +75 dB input gain, 150 $\Omega$ input)		
Outputs	Line output	Connectors 3.5 mm stereo mini unbalanced output
		Output impedance 100 $\Omega$ or less
		Reference output level -10 dBV, 1 kHz, 10k $\Omega$ load
		Maximum output level +10 dBV, 1 kHz, 10k $\Omega$ load
		D/A dynamic range 95 dB typ (-60dBFS input, A-weighted)
	Headphone output	Connector 3.5 mm stereo mini unbalanced output
		Output impedance 15 $\Omega$ or less
		Maximum output level 100 mW + 100 mW (32 $\Omega$ load)
		D/A dynamic range 108 dB typ (-60dBFS input, A-weighted)
Recording formats	When WAV selected	
	Supported formats	44.1/47.952/48/48.048/88.2/96/192 kHz, 16/24-bit/32-bit float, mono/stereo/2-8ch poly, BWF/iXML supported
	Maximum simultaneous recording tracks	14 (6 inputs x 2 (Liner and Floating) + LR mix) 6 (6 inputs (Liner or Floating) at 192kHz sampling rate)
	When MP3 selected	
	Supported formats	128/192/320kbps, 44.1/48 kHz, ID3v1 tags supported
	Maximum simultaneous recording tracks	2
Recording time	Using a 32 GB card	
	30:46:00 (48 kHz/24-bit stereo WAV)	
	7:41:00 (192 kHz/24-bit stereo WAV)	
Timecode	Connector	3.5 mm stereo mini (Tip: IN, Ring: OUT)
	Modes	Off, Int Free Run, Int Record Run, Int RTC Run, Ext, Ext Auto Rec (audio clock can be synchronized to timecode)
	Frame rates	23.976 ND, 24 ND, 25 ND, 29.97 ND, 29.97 D, 30 ND, 30 D
	Precision	$\pm 0.2$ ppm
	Allowed input level	0.2 – 5.0 Vpp
	Allowed input impedance	4.6 k $\Omega$
	Output level	3.3 Vpp
	Output impedance	50 $\Omega$ or less
Power	AC adapter (ZOOM AD-17): DC 5V/1A (supports USB bus power)	
	Sony® L-Series battery	
	4 AA batteries (alkaline, lithium or rechargeable NiMH batteries)	

Continuous recording time	48 kHz/16-bit 2ch recording to SD card (LINE OUT off, TIMECODE off, LED/LCD Brightness 5, headphones into 32Ω load, PHANTOM off)			
	Alkaline batteries	7.5 hours or more		
	NiMH batteries (2450 mAh)	10.5 hours or more		
	Lithium batteries	16.5 hours or more		
	48 kHz/24-bit 6ch recording to SD card (LINE OUT off, TIMECODE off, LED/LCD Brightness 5, headphones into 32Ω load, PHANTOM off)			
	Alkaline batteries	5 hours or more		
	NiMH batteries (2450 mAh)	7 hours or more		
	Lithium batteries	10.5 hours or more		
	192 kHz/24-bit 6ch recording to SD card (LINE OUT on, TIME CODE set to Int Free Run, LED/LCD Brightness 60, headphones into 32Ω load, PHANTOM at 48 V)			
	Alkaline batteries	0.5 hours or more		
NiMH batteries (2450 mAh)	1.5 hours or more			
Lithium batteries	3.5 hours or more			
Display	1.54" full-color LCD (240 × 240)			
USB	Mass storage operation			
	Class	USB 2.0 High Speed		
	Multitrack audio interface operation (driver required for Windows, no driver required for macOS)			
	Class	USB 2.0 High Speed		
	Specifications	Sampling rate	44.1/48/88.2/96 kHz	
		Bit Rate	16/24-bit	
		Channels	6 in/4 out	
	Stereo mix audio interface operation (no driver required)			
	Class	USB 2.0 Full Speed		
	Specifications	Sampling rate	44.1/48 kHz	
		Bit Rate	16-bit	
		Channels	2 in/2 out	
	Note: iOS device audio interface operation supported (stereo mode only)			
	AIF with Rec operation (driver required for Windows, no driver required for macOS)			
	Class	USB 2.0 High Speed		
	Specifications	Sampling rate	44.1/48 kHz	
		Bit Rate	16/24-bit	
Channels		8 in/4 out		
Power consumption	Main unit only	1 W		
	Using L battery with FRC-8 connected	10 W		
External dimensions	100 mm (W) × 119.8 mm (D) × 62.9 mm (H)			
Weight	520 g			



**ZOOM CORPORATION**

4-4-3 Kanda-surugadai, Chiyoda-ku, Tokyo 101-0062 Japan

[www.zoom.co.jp](http://www.zoom.co.jp)